

2025 GENERAL CATALOGUE

# The BRAND of RESPONSIBLE BRANDS





**OFFICIAL RESELLER**

[www.epengadget.com](http://www.epengadget.com)

THE BRAND OF  
RESPONSIBLE BRANDS



THINK BIC

# WHY WE DO WHAT WE DO

---

**Our mission is simple: to create lasting, sustainable solutions that help businesses thrive while protecting the planet. Since 1995, at BIC Graphic we have consistently innovated to offer creative, sustainable, and long-lasting solutions to personalise iconic BIC products. We've been driven by a commitment to responsible practices and believe in the power of thoughtful innovation, where every product is a step towards minimising our carbon footprint. From using energy coming from renewable sources to working with local suppliers who share our values, we ensure that sustainability is not just a goal, but a way of doing business.**

**That's why you'll find our exciting new products made in Europe, including the BIC® EZ Reach™, the BIC® Cristal® Expression that writes up to 3 km, the BIC® Kids Evolution® Colouring Set and the BIC® Media Clic Biobased, available in trendy Pastel colours. These products reflect our ongoing commitment to quality, innovation and responsibility.**

**BIC Graphic. The Brand of Responsible Brands.**

FR

## **POURQUOI FAISONS-NOUS CE QUE NOUS FAISONS**

Notre mission est simple : créer des solutions durables et responsables qui aident les entreprises à prospérer tout en prenant soin de la planète. Depuis 1995, chez BIC Graphic, nous avons constamment pour offrir des solutions créatives, durables et pérennes afin de personnaliser les produits emblématiques de BIC. Animés par un engagement envers des pratiques responsables, nous croyons au pouvoir d'une innovation réfléchie, où chaque produit représente une avancée vers la réduction de notre empreinte carbone. De l'utilisation d'énergie provenant de sources renouvelables à notre collaboration avec des fournisseurs locaux qui partagent nos valeurs, nous veillons à ce que la durabilité ne soit pas seulement un objectif, mais une façon de faire des affaires.

C'est pourquoi, dans cette édition, vous découvrirez nos nouvelles créations fabriquées en Europe, notamment le BIC® EZ Reach™, le BIC® Cristal® Expression, qui écrit jusqu'à 3 km, le BIC® Kids Evolution® Colouring Set et le BIC® Media Clic Biobased, disponible dans des couleurs Pastel tendances. Ces produits reflètent notre engagement continu envers la qualité, l'innovation et la responsabilité.

BIC Graphic. The Brand of Responsible Brands.

DE

## **WARUM TUN WIR, WAS WIR TUN**

Unsere Mission ist einfach: nachhaltige Lösungen zu schaffen, die Unternehmen dabei unterstützen, erfolgreich zu sein, während wir gleichzeitig für unseren Planeten sorgen. Seit 1995 haben wir bei BIC Graphic kontinuierlich Innovationen entwickelt, um kreative, nachhaltige und langlebige Lösungen für die Personalisierung der kultigen BIC-Produkte anzubieten. Unser Handeln wird von einem Engagement für verantwortungsvolle Praktiken geprägt, und wir glauben an die Kraft durchdachter Innovationen, bei denen jedes Produkt einen Schritt zur Minimierung unseres Kohlenstoff-Fußabdrucks darstellt. Von der Nutzung von Strom aus erneuerbaren Energien bis hin zur Zusammenarbeit mit lokalen Lieferanten, die unsere Werte teilen, stellen wir sicher, dass Nachhaltigkeit nicht nur ein Ziel, sondern eine Arbeitsweise ist.

Deshalb finden Sie in dieser Ausgabe unsere spannenden neuen Produkte, die in Europa gefertigt werden, wie den BIC® EZ Reach™, den BIC® Cristal® Expression, der bis zu 3 km schreibt, das BIC® Kids Evolution® Colouring Set und den BIC® Media Clic Biobased, erhältlich in angesagten Pastel-Farben. Diese Produkte spiegeln unser kontinuierliches Engagement für Qualität, Innovation und Verantwortung wider.

BIC Graphic. The Brand of Responsible Brands.

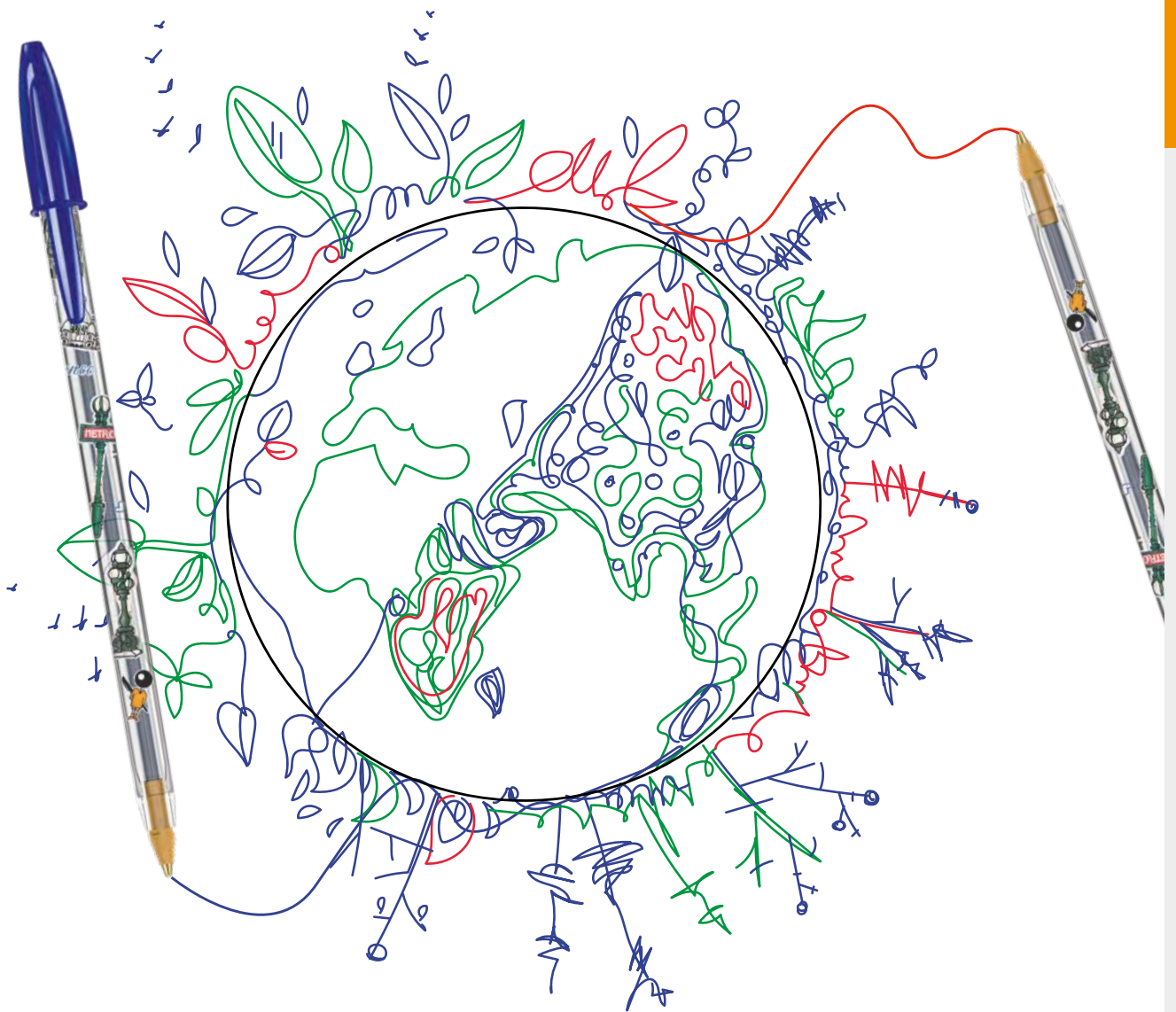

IT

### PERCHÉ FACCIAMO QUELLO CHE FACCIAMO

La nostra missione è semplice: creare soluzioni durature e sostenibili che aiutino le aziende a prosperare, prendendosi cura del pianeta. Dal 1995 presso BIC Graphic, abbiamo costantemente per offrire soluzioni creative, sostenibili e durature per personalizzare i prodotti iconici BIC. Guidati da un impegno verso pratiche responsabili, crediamo nel potere dell'innovazione consapevole, in cui ogni prodotto rappresenta un passo avanti verso la riduzione della nostra impronta di carbonio. Dall'uso di energia proveniente da fonti rinnovabili alla collaborazione con fornitori locali che condividono i nostri valori, ci assicuriamo che la sostenibilità non sia solo un obiettivo, ma un modo di fare impresa.

Ecco perché, in questa edizione, troverete le nostre nuove proposte realizzate in Europa, tra cui il BIC® EZ Reach™, il BIC® Cristal® Expression, che scrive fino a 3 KM, il BIC® Kids Evolution® Colouring Set e il BIC® Media Clic Biobased, disponibile in colori pastel alla moda. Questi prodotti riflettono il nostro costante impegno verso la qualità, l'innovazione e la responsabilità.

BIC Graphic. The Brand of Responsible Brands.

ES

### ¿POR QUÉ HACEMOS LO QUE HACEMOS?

Nuestra misión es simple: crear soluciones duraderas y sostenibles que ayuden a las empresas a prosperar mientras cuidamos del planeta. Desde 1995, en BIC Graphic, hemos innovado constantemente para ofrecer soluciones creativas, sostenibles y duraderas para personalizar los productos icónicos de BIC. Impulsados por un compromiso con prácticas responsables, creemos en el poder de la innovación consciente, donde cada producto es un paso hacia la minimización de nuestra huella de carbono. Desde el uso de energía proveniente de fuentes renovables hasta trabajar con proveedores locales que comparten nuestros valores, nos aseguramos de que la sostenibilidad no sea solo un objetivo, sino una forma de hacer negocios.

Por eso, en esta edición, encontrarás nuestros emocionantes nuevos lanzamientos fabricados en Europa, como el BIC® EZ Reach™, el BIC® Cristal® Expression, que escribe hasta 3 KM, el BIC® Kids Evolution® Colouring Set e el BIC® Media Clic Biobased, disponible en colores pastel de tendencia. Estos productos reflejan nuestro continuo compromiso con la calidad, la innovación y la responsabilidad.

BIC Graphic. The Brand of Responsible Brands.

## BIC GRAPHIC

3

The Brand of Responsible Brands	2	Sustainable Products	20
Think BIC	4	75th anniversary of BIC® Cristal®	22
Contents	6	Novelties	24
Exploring BIC Graphic	8	BIC® Collection Boxes	32
Sustainability	12	Printing Techniques	34
Made in Europe	18	Full Colour britePix™ Digital Range	36

## BIC® WRITING INSTRUMENTS

38

### BALLPENS

BIC® Cristal® Expression	40
BIC® Cristal® Re'New™	44
BIC® Style	48
BIC® Round Stic®	52
BIC® Round Stic® BGuard™ antibacterial	54
BIC® Round Stic® Ecolutions®	55
BIC® M10® Clic	58
BIC® Media Clic	62
BIC® Media Clic Ecolutions®	63
BIC® Media Clic Grip	65
BIC® Media Clic Grip Ecolutions®	66
BIC® Media Clic BGuard™ antibacterial	72
BIC® Media Clic BGuard™ antimicrobial Ecolutions®	74
BIC® Media Clic Biobased Ecolutions®	76
BIC® Media Clic Biobased BGuard™ antibacterial	80
BIC® Media Clic Shine	82
BIC® Media Clic Glacé	84
BIC® Clic Stic	86
BIC® Clic Stic Ecolutions®	87
BIC® Clic Stic Stylus	90
BIC® Clic Stic Stylus Ecolutions®	90
BIC® Super Clip	96
BIC® Super Clip Ecolutions®	97
BIC® Super Clip Advance	100
BIC® Super Clip Glacé	104
BIC® Super Clip Glacé Advance	104
BIC® Super Clip Soft	106
BIC® Super Clip Soft Advance	106
BIC® Super Clip Origin	108
BIC® Wide Body™	112
BIC® Wide Body™ Ecolutions®	113
BIC® 4 Colours®	120
BIC® 4 Colours® Rainbow Decor	122
BIC® 4 Colours® Bicolor	124
BIC® 4 Colours® Gradient	126
BIC® 4 Colours® Pastel	128
BIC® 4 Colours® Fashion	130

BIC® 4 Colours® Sun	132
BIC® 4 Colours® Fine	134
BIC® 4 Colours® Fluo	136
BIC® 4 Colours® Glacé	138
BIC® 4 Colours® Shine	140
BIC® 4 Colours® Soft	142
BIC® 4 Colours® Wood Style	144
BIC® 4 Colours® Flags Collection	146
BIC® 4 Colours® 3+1 <sup>HB</sup>	148

### METALLIC PENS

BIC® Metal Pro	150
----------------	-----

### ROLLERS AND GELS

BIC® Grip Roller	156
BIC® XS Finestyle	158
BIC® Intensity® Gel Clic	160

### HIGHLIGHTERS AND MARKERS

BIC® Brite Liner® Grip	164
BIC® Velleda® White Board Marker Fine	166
BIC® Velleda® White Board Marker Grip	167
BIC® Mark-It Permanent Marker	168
BIC® Permanent Marker Ecolutions®	169

### MECHANICAL PENCILS

BIC® Matic®	172
BIC® Matic® Ecolutions®	172
BIC® Media Clic Mechanical pencil	174
BIC® Media Clic Grip Mechanical pencil	175
BIC® Media Clic Grip Mechanical pencil Ecolutions®	175

### PENCILS

BIC® Evolution® Ecolutions®	180
BIC® Kids Evolution® Colouring Set	184
Sprout™ Graphite pencil	186

# OUR STORY

---

**With over 80 years of brand heritage, we at BIC Graphic stand out for our commitment to innovation, affordability and excellence. Rooted in our core values of customer service, social responsibility and sustainable development, we proudly lead the promotional marketing sector in Europe, the Middle East and Africa. Our creative, sustainable solutions help elevate our customers' brands.**

FR

## NOTRE HISTOIRE

Nous sommes la division du Groupe BIC qui personnalise les produits BIC®, basée à Tarragone, en Espagne, depuis 1995.

Avec plus de 80 ans d'héritage de marque, nous, chez BIC Graphic, nous nous distinguons par notre engagement envers l'innovation, l'accessibilité et l'excellence. Fondés sur nos valeurs fondamentales de service client, de responsabilité sociale et de développement durable, nous sommes fiers de diriger le secteur du marketing promotionnel en Europe, au Moyen-Orient et en Afrique. Nos solutions créatives et durables aident à valoriser les marques de nos clients.

IT

## LA NOSTRA STORIA

Siamo la divisione del Gruppo BIC che personalizza i prodotti BIC®, con sede a Tarragona, Spagna, dal 1995.

Con oltre 80 anni di eredità del marchio, noi di BIC Graphic ci distinguiamo per il nostro impegno verso l'innovazione, l'accessibilità e l'eccellenza. Radicati nei nostri valori fondamentali di servizio clienti, responsabilità sociale e sviluppo sostenibile, guidiamo con orgoglio il settore del marketing promozionale in Europa, Medio Oriente e Africa. Le nostre soluzioni creative e sostenibili aiutano a elevare i marchi dei nostri clienti.

DE

## UNSERE GESCHICHTE

Wir sind der Geschäftsbereich der BIC-Gruppe, der BIC®-Produkte personalisiert und seit 1995 in Tarragona, Spanien ansässig ist.

Mit über 80 Jahren Markengeschichte zeichnen wir uns bei BIC Graphic durch unser Engagement für Innovation, Erschwinglichkeit und Exzellenz aus. Basierend auf unseren Grundwerten Kundenservice, soziale Verantwortung und nachhaltige Entwicklung führen wir stolz den Werbemarkt in Europa, dem Nahen Osten und Afrika an. Unsere kreativen, nachhaltigen Lösungen helfen dabei, die Marken unserer Kunden zu stärken.

ES

## NUESTRA HISTORIA

Somos la división del Grupo BIC que personaliza los productos BIC®, con sede en Tarragona, España, desde 1995.

Con más de 80 años de herencia de marca, en BIC Graphic nos destacamos por nuestro compromiso con la innovación, la accesibilidad y la excelencia. Basados en nuestros valores fundamentales de servicio al cliente, responsabilidad social y desarrollo sostenible, lideramos con orgullo el sector del marketing promocional en Europa, Oriente Medio y África. Nuestras soluciones creativas y sostenibles ayudan a elevar las marcas de nuestros clientes.

We are the division of the BIC Group that personalises BIC® products, based in Tarragona, Spain since 1995.

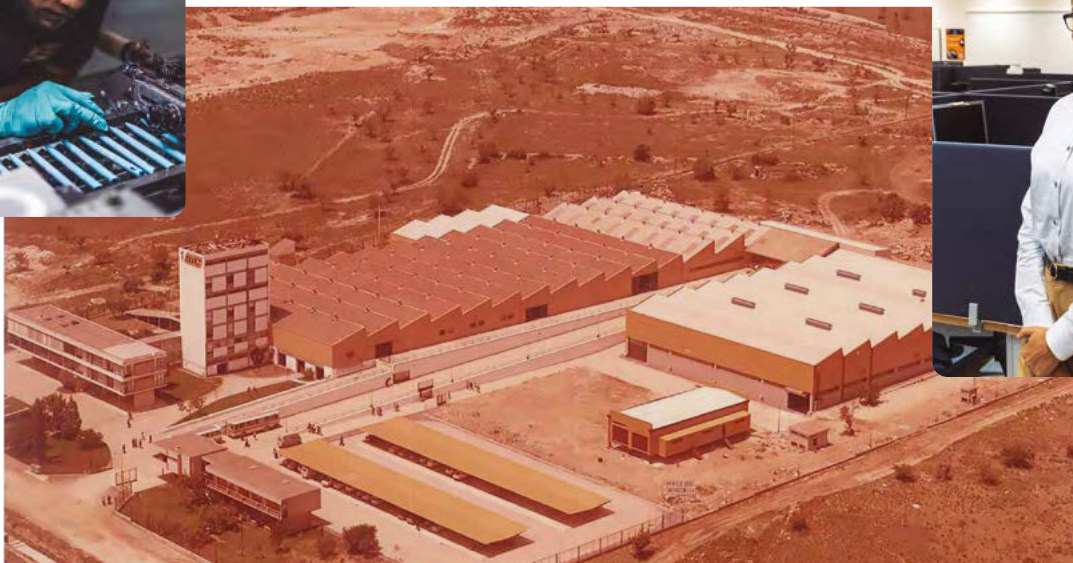

# OUR PILLARS

---

## FR NOS PILIERS

**Iconique et innovant.** Animés par une passion pour l'innovation, nous introduisons des techniques de personnalisation de pointe, lançons des produits durables de meilleure qualité et ajoutons des finitions tendance à nos articles les plus emblématiques. En tant que marque de renommée mondiale, BIC Graphic reste un symbole de créativité tournée vers l'avenir.

**Responsable.** BIC Graphic est une référence de confiance pour les normes les plus élevées en matière de qualité et de sécurité, fermement engagée envers la responsabilité sociale, environnementale et éthique.

**Proche de vous.** Nous avons toujours été à vos côtés lors des moments importants de votre vie, comprenant vos besoins comme s'ils étaient les nôtres. C'est pourquoi nous offrons une parfaite personnalisation grâce à des outils numériques, facilitant la création de ce que vous imaginez. Notre engagement en faveur de la production locale nous rapproche encore plus de vous tout en contribuant à réduire notre empreinte carbone.

## IT I NOSTRI PILASTRI

**Iconico e innovativo.** Guidati da una passione per l'innovazione, introduciamo tecniche di personalizzazione all'avanguardia, lanciamo prodotti sostenibili di qualità superiore e aggiungiamo finiture di tendenza ai nostri articoli più iconici. Come marchio di fama mondiale, BIC Graphic rimane un simbolo di creatività orientata al futuro.

**Responsabile.** BIC Graphic è un punto di riferimento affidabile per i più alti standard di qualità e sicurezza, con un impegno fermo verso la responsabilità sociale, ambientale ed etica.

**Vicino a te.** Siamo sempre stati al tuo fianco nei momenti importanti della tua vita, comprendendo i tuoi bisogni come fossero i nostri. Per questo offriamo una personalizzazione semplice e intuitiva con strumenti digitali, rendendo facile creare ciò che immagini. Il nostro impegno per la produzione locale ci avvicina ulteriormente a te, contribuendo al contempo a ridurre la nostra impronta di carbonio.

## DE UNSERE GRUNDSÄTZE

**Legendär und innovativ.** Angetrieben von einer Leidenschaft für Innovation, führen wir modernste Personalisierungstechniken ein, bringen nachhaltigere, hochwertigere Produkte auf den Markt und fügen unseren legendären Artikeln trendige Veredelungen hinzu. Als weltweit bekannte Marke bleibt BIC Graphic ein Symbol für zukunftsweisende Kreativität.

**Zuverlässig.** BIC Graphic ist ein vertrauenswürdiger Maßstab für höchste Standards in Qualität und Sicherheit und fest verpflichtet zu sozialer, ökologischer und ethischer Verantwortung.

**An Ihrer Seite.** Wir sind immer gewesen in den wichtigen Momenten des Lebens an Ihrer Seite und verstehen Ihre Bedürfnisse, als wären es unsere eigenen. Deshalb bieten wir nahtlose Personalisierung mit modernster Technik, die es einfach macht, genau das zu gestalten, was Sie sich vorstellen. Unser Engagement für lokale Produktion bringt uns noch näher zu Ihnen und trägt gleichzeitig dazu bei, unseren CO2-Fußabdruck zu verringern.

## ES NUESTROS PILARES

**Iconicos e innovadores.** Impulsados por una pasión por la innovación, introducimos técnicas de personalización de vanguardia, lanzamos productos sostenibles de mayor calidad y añadimos acabados vanguardistas a nuestros artículos más icónicos. Como una marca reconocida mundialmente, BIC Graphic sigue siendo un símbolo de creatividad con visión de futuro.

**Confiables.** BIC Graphic es un referente confiable de los más altos estándares de calidad y seguridad, firmemente comprometido con la responsabilidad social, ambiental y ética.

**Cerca de ti.** Siempre hemos estado a tu lado en los momentos importantes de la vida, entendiendo tus necesidades como si fueran nuestras. Por eso ofrecemos una personalización fluida con herramientas digitales, facilitando la creación de lo que imaginas. Nuestro compromiso con la producción local nos acerca aún más a ti mientras ayudamos a reducir nuestra huella de carbono.

# Iconic and innovative

Driven by a passion for innovation, we introduce cutting-edge customisation techniques, launch higher-quality, sustainable products, and add trendsetting finishes to our most iconic items. As a world-renowned brand, BIC Graphic remains a symbol of forward-thinking creativity.

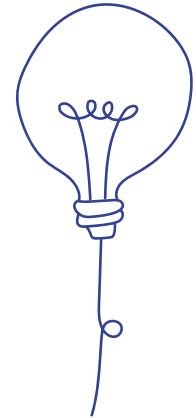

## ✓ Trusted

BIC Graphic is a trusted benchmark for the highest standards in quality and safety, firmly committed to social, environmental and ethical responsibility.

## Close to you

We've always been by your side through life's important moments, understanding your needs as if they were our own. That's why we offer seamless customisation with digital tools, making it easy to create exactly what you envision. Our commitment to local production brings us even closer to you while helping to reduce our carbon footprint.



# The BRAND of RESPONSIBLE BRANDS

1

We were  
born A  
RESPONSIBLE  
BRAND

Our primary objective is to manufacture and customise the most useful and longest-lasting products on the market, thereby conserving natural resources.



FR

**1. NOUS SOMMES NÉS POUR ÊTRE UNE MARQUE RESPONSABLE**

Notre premier objectif est de fabriquer et de personnaliser les produits les plus utiles et les plus durables du marché, de sorte à préserver les ressources naturelles.

DE

**1. WIR SIND ALS VERANTWORTUNGSBEWUSSTE MARKE ENTSTANDEN**

Unser Hauptziel ist es, die nützlichsten und langlebigsten Produkte auf dem Markt herzustellen und individuell zu gestalten und dabei natürliche Ressourcen zu schonen.

IT

**1. SIAMO NATI COME MARCHIO RESPONSABILE**

Il nostro obiettivo principale è quello di produrre e personalizzare i prodotti più utili e duraturi presenti sul mercato, preservando allo stesso tempo le risorse naturali.

ES

**1. NACEMOS COMO UNA MARCA RESPONSABLE**

Nuestro principal objetivo es fabricar y personalizar los productos más útiles y duraderos del mercado, conservando los recursos naturales.

# 2

# *innovation* is in our NATURE

Rethink everything.  
There is still so much to be discovered.  
The invented can be reinvented.  
That's our approach.



FR

## **2. L'INNOVATION EST DANS NOTRE NATURE**

Tout repenser. Il reste encore tant de choses à découvrir.  
Ce qui a été inventé peut être réinventé. C'est notre approche.

IT

## **L'INNOVAZIONE FA PARTE DELLA NOSTRA NATURA**

Ripensare tutto. C'è ancora tanto da scoprire.  
L'inventato può essere reinventato. È questo il nostro approccio.

DE

## **2. INNOVATION LIEGT IN UNSERER NATUR**

Alles neu denken. Es gibt noch so viel zu entdecken.  
Erfundenes kann neu erfunden werden. Das ist unser Konzept.

ES

## **2. LA INNOVACIÓN ESTÁ EN NUESTRA NATURALEZA**

Replantarse todo. Aún queda mucho por descubrir.  
Lo inventado puede reinventarse. Ese es nuestro enfoque.

# 3

# WE WORK to Create SOLUTIONS WITHOUT CREATING problems

Working to provide solutions for companies, while minimising our environmental footprint. We do this using only renewable energy. Moreover, we prioritise the use of biobased and recycled materials in the manufacturing process.



FR

### **3. NOUS TRAVAILLONS POUR CRÉER DES SOLUTIONS SANS CRÉER DE PROBLÈMES**

Nous travaillons pour apporter des solutions aux entreprises, tout en minimisant notre empreinte environnementale. À cette fin, nous utilisons exclusivement des énergies renouvelables. En outre, nous privilégions l'utilisation de matériaux biosourcés et recyclés dans le processus de fabrication.

(IT)

### **3. LAVORIAMO PER CREARE SOLUZIONI SENZA CREARE PROBLEMI**

Lavorare per fornire soluzioni alle aziende, riducendo al minimo il nostro impatto ambientale. A tal fine, utilizziamo esclusivamente energia rinnovabile. Inoltre, diamo priorità all'uso di materiali biobased e riciclati nel processo di produzione.

DE

### **3. WIR WOLLEN LÖSUNGEN SCHAFFEN, OHNE PROBLEME ZU VERURSACHEN**

Wir suchen nach Lösungen für Unternehmen und minimieren gleichzeitig unseren ökologischen Fußabdruck. Zu diesem Zweck verwenden wir ausschließlich erneuerbare Energien. Darüber hinaus verwenden wir bei der Herstellung vorrangig biobasierte und recycelte Materialien.

ES

### **3. TRABAJAMOS PARA CREAR SOLUCIONES SIN CREAR PROBLEMAS**

Trabajamos para ofrecer soluciones a las empresas, minimizando al mismo tiempo nuestra huella medioambiental. Para ello utilizamos exclusivamente energías renovables. Además, damos prioridad al uso de materiales biológicos y reciclados en el proceso de fabricación.

# 4

# WE ARE PEOPLE WORKING FOR PEOPLE

The way we do business is just as important as the outcome of our efforts. We manufacture and customise in Europe, maintaining the highest standards of health and safety while promoting equality, diversity and inclusion in the workplace. We also believe that education is a catalyst to improve people's lives. That's why we promote education around the world through the BIC Corporate Foundation.



FR

#### **4. NOUS SOMMES DES PERSONNES QUI TRAVAILLENT AU SERVICE D'AUTRES PERSONNES**

Notre manière de travailler est tout aussi importante que le résultat de nos efforts. Nous fabriquons et personnalisons nos produits en Europe, en respectant les normes les plus strictes en matière de santé et de sécurité, et en œuvrant en faveur de l'égalité, de la diversité et de l'inclusion sur le lieu de travail. Nous croyons également que l'éducation est un catalyseur pour améliorer la vie des personnes. C'est pourquoi nous nous efforçons de promouvoir l'éducation dans le monde, par le biais de la Fondation d'entreprise BIC.

IT

#### **4. SIAMO PERSONE CHE LAVORANO PER LE PERSONE**

Il modo in cui conduciamo la nostra attività è importante quanto il risultato del nostro impegno. Produciamo e personalizziamo in Europa, mantenendo i più elevati standard di salute e sicurezza, promuovendo al contempo l'uguaglianza, la diversità e l'inclusione sul posto di lavoro. Crediamo anche che l'istruzione sia un catalizzatore per migliorare la vita delle persone. Ecco perché promuoviamo l'istruzione in tutto il mondo attraverso la BIC Corporate Foundation.

DE

#### **4. WIR SIND MENSCHEN, DIE FÜR MENSCHEN ARBEITEN**

Die Art und Weise, wie wir tätig sind, ist genauso wichtig wie das Ergebnis unserer Bemühungen. Wir fertigen und personalisieren unsere Produkte in Europa, unter Einhaltung höchster Gesundheits- und Sicherheitsstandards und fördern Gleichstellung, Vielfalt und Integration am Arbeitsplatz. Wir sind auch der Ansicht, dass Bildung ein Schlüsselfaktor für die Verbesserung der Lebensqualität von Menschen ist. Deshalb fördern wir weltweit Bildung durch die BIC Corporate Foundation.

ES

#### **4. SOMOS PERSONAS QUE TRABAJAN PARA PERSONAS**

La forma en que hacemos negocios es tan importante como el resultado de nuestros esfuerzos. Fabricamos y personalizamos en Europa, manteniendo los más altos niveles de salud y seguridad a la vez que promovemos la igualdad, la diversidad y la inclusión en el lugar de trabajo. También creemos que la educación es un catalizador para mejorar la vida de las personas. Por eso promovemos la educación en todo el mundo a través de la Fundación Corporativa BIC.

# 5 A BETTER US. BETTER CLOSE BY

Our company manufactures and customises products in Europe. With our own factories, we ensure sustainable work processes of the highest quality. What's more, by remaining close to our customers and suppliers, we are able to reduce delivery times and significantly minimise our carbon footprint. That's because our products don't travel halfway around the world to reach their destination.

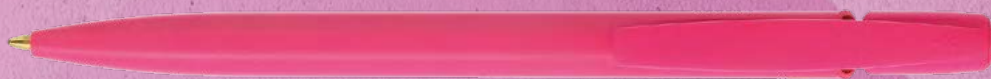

FR

## 5. MIEUX FAIRE. EN ÉTANT PLUS PROCHES

Nous fabriquons et personnalisons nos produits en Europe. Nous disposons de nos propres usines, ce qui nous permet de garantir des processus de travail durables et de la plus haute qualité. De plus, en restant proches de nos clients et de nous fournisseur, nous sommes en mesure de réduire les délais de livraison et de minimiser notre empreinte carbone de manière significative. Parce que nos produits ne parcourent pas la moitié du monde pour atteindre leur destination.

IT

## 5. MEGLIO LA PROSSIMITÀ. PER ESSERE MIGLIORI

La nostra azienda produce e personalizza prodotti in Europa. Attraverso stabilimenti di produzione propri garantiamo processi di lavorazione sostenibili di massima qualità. Inoltre, grazie alla prossimità con i nostri fornitori, siamo in grado di ridurre i tempi di consegna e abbattere significativamente la nostra impronta di carbonio perché i nostri prodotti non devono attraversare il mondo per giungere a destinazione.

DE

## 5. EIN BESSERES WIR. NÄHER IST BESSER

Unser Unternehmen fertigt Produkte maßgeschneidert in Europa. Mit unseren eigenen Fabriken gewährleisten wir nachhaltige Arbeitsprozesse von höchster Qualität. Darüber hinaus verringern wir durch die Nähe zu unseren Lieferanten die Lieferzeiten und minimieren unseren Co2-Fußabdruck erheblich. Das liegt daran, dass unsere Produkte nicht um die ganze Welt reisen, um an ihren Bestimmungsort zu gelangen.

ES

## 5. UN NOSOTROS ES MEJOR. MÁS CERCA ES MEJOR

Nuestra empresa fabrica y personaliza productos en Europa. Con nuestras propias fábricas, garantizamos procesos de trabajo sostenibles y de la máxima calidad. Además, al permanecer cerca de nuestros clientes y proveedores, podemos reducir los plazos de entrega y minimizar significativamente nuestra huella de carbono. Eso se debe a que nuestros productos no recorren medio mundo para llegar a su destino.

# 6

## WE ARE RESPONSIBLE FROM BEGINNING TO END

It is not enough for us to be responsible in manufacturing. We also want to work with local suppliers who share our respect for people and the planet and are willing to assume our commitments. In addition, we assume a responsibility to our clients; we understand that we have a commitment to people, the environment, quality and service. These are essential elements of the way we do business.



FR

### 6. NOUS SOMMES RESPONSABLES DU DÉBUT À LA FIN

Pour nous, la responsabilité ne se limite pas à la fabrication. Nous voulons également travailler avec des fournisseurs locaux qui partagent notre respect des personnes et de la planète et qui sont prêts à assumer nos engagements. Nous assumons également une responsabilité envers nos clients, en étant conscients que notre expérience signifie notre engagement envers les personnes, l'environnement, la qualité et le service. Ce sont des aspects essentiels de notre façon de mener nos activités.

IT

### 6. RESPONSABILI DALL'INIZIO ALLA FINE

Per noi non è sufficiente essere responsabili nel settore manifatturiero. Vogliamo anche lavorare con fornitori locali che condividono il nostro rispetto per le persone e il pianeta, e siamo pronti a farci carico dei nostri impegni. Ci assumiamo anche la responsabilità nei confronti dei nostri clienti, sapendo che la nostra esperienza significa che abbiamo assunto un impegno nei confronti delle persone, dell'ambiente, della qualità e del servizio. Questi fattori sono essenziali nel nostro modo di lavorare.

DE

### 6. WIR SIND VERANTWORTUNGSBEWUSST VON ANFANG BIS ENDE

Nur in der Produktion verantwortungsbewusst zu sein, genügt uns nicht. Wir wollen auch mit lokalen Lieferanten zusammenarbeiten, die unsere Achtung vor Menschen und dem Planeten teilen und bereit sind, unser Engagement zu übernehmen. Wir übernehmen auch Verantwortung für unsere Kunden, da wir uns aufgrund unserer Erfahrung den Menschen, der Umwelt, der Qualität und dem Service verpflichtet fühlen. Diese Faktoren sind wesentliche Bestandteile unserer Geschäftstätigkeit.

ES

### 6. SOMOS RESPONSABLES DE PRINCIPIO A FIN

No nos basta con ser responsables en la fabricación. También queremos trabajar con proveedores locales que compartan nuestro respeto por las personas y el planeta y estén dispuestos a asumir nuestros compromisos. También asumimos una responsabilidad con nuestros clientes; entendemos que tenemos un compromiso con las personas, el medio ambiente, la calidad y el servicio. Estos son elementos esenciales de nuestra forma de hacer negocios.

# MADE IN EUROPE: CLOSE TO YOU

---

**“Made in Europe” is more than a label. Since 1950, it has been central to BIC’s promise of quality and sustainability. From our origins in France to personalised creations in Tarragona, Spain, we design and produce select writing instruments and lighters locally, keeping production close to you.**

**This approach minimises shipping distances and reduces our environmental footprint by sourcing materials from European suppliers and producing on demand. Our ISO 14001 and 9001-certified facilities uphold the highest standards of quality, sustainability, and employee safety.**

**Being close to our customers and suppliers ensures faster production, better supply chain control, and fewer delays. “Made in Europe” isn’t just a location—it’s our commitment to responsibility, connection, and quality.**

## FR FABRIQUÉ EN EUROPE : PROCHE DE VOUS

„Fabriqué en Europe“ est bien plus qu’un label. Depuis 1950, il est au cœur de l’engagement de BIC pour la qualité et la durabilité. De nos origines en France à nos créations personnalisées à Tarragone, en Espagne, nous concevons et produisons localement des instruments d’écriture et des briquets sélectionnés, en restant proches de vous.

Cette approche réduit les distances de transport et notre empreinte écologique grâce à l’approvisionnement en matériaux auprès de fournisseurs européens et à une production à la demande. Nos installations certifiées ISO 14001 et 9001 respectent les normes les plus élevées de qualité, de durabilité et de sécurité des employés.

Être proches de nos clients et de nos fournisseurs permet une production plus rapide, un meilleur contrôle de la chaîne d’approvisionnement et moins de retards. „Fabriqué en Europe“ ne se limite pas à un lieu – c’est notre engagement envers la responsabilité, la proximité et la qualité.

## DE HERGESTELLT IN EUROPA: NAH BEI IHNEN

„Hergestellt in Europa“ ist mehr als nur ein Label. Seit 1950 steht es im Mittelpunkt des BIC-Versprechens für Qualität und Nachhaltigkeit. Von unseren Ursprüngen in Frankreich bis hin zu personalisierten Kreationen in Tarragona, Spanien, entwerfen und produzieren wir ausgewählte Schreibgeräte und Feuerzeuge lokal, in Ihrer Nähe.

Dieser Ansatz minimiert Transportwege und reduziert unseren ökologischen Fußabdruck durch die Beschaffung von Materialien von europäischen Lieferanten und die Produktion auf Abruf. Unsere nach ISO 14001 und 9001 zertifizierten Anlagen erfüllen höchste Standards in Qualität, Nachhaltigkeit und Arbeitssicherheit.

Die Nähe zu unseren Kunden und Lieferanten ermöglicht schnellere Produktion, bessere Kontrolle der Lieferkette und weniger Verzögerungen. „Hergestellt in Europa“ ist nicht nur ein Standort – es steht für unsere Verantwortung, Verbundenheit und Qualität.



**IT**  
**MADE IN EUROPE: VICINO A TE**

“Made in Europe” è più di un’etichetta. Dal 1950, è al centro dell’impegno di BIC per qualità e sostenibilità. Dalle nostre origini in Francia alle creazioni personalizzate a Tarragona, in Spagna, progettiamo e produciamo localmente strumenti di scrittura e accendini selezionati, rimanendo vicini a voi.

Questo approccio riduce le distanze di trasporto e l’impatto ambientale grazie all’approvvigionamento di materiali da fornitori europei e alla produzione su richiesta. Le nostre strutture certificate ISO 14001 e 9001 rispettano i più alti standard di qualità, sostenibilità e sicurezza dei dipendenti.

Essere vicini ai nostri clienti e fornitori ci permette una produzione più rapida, un maggiore controllo della catena di fornitura e meno ritardi. “Made in Europe” non è solo un luogo: è il nostro impegno per responsabilità, connessione e qualità.

**ES**  
**HECHO EN EUROPA: CERCA DE TI**

“Hecho en Europa” es más que una etiqueta. Desde 1950, ha sido parte central del compromiso de BIC con la calidad y la sostenibilidad. Desde nuestros orígenes en Francia hasta las creaciones personalizadas en Tarragona, España, diseñamos y producimos localmente instrumentos de escritura y encendedores seleccionados, manteniendo la producción cerca de ti.

Este enfoque minimiza las distancias de envío y reduce nuestra huella ambiental al obtener materiales de proveedores europeos y producir bajo demanda. Nuestras instalaciones, certificadas con ISO 14001 y 9001, cumplen con los más altos estándares de calidad, sostenibilidad y seguridad laboral.

Estar cerca de nuestros clientes y proveedores asegura una producción más rápida, mejor control de la cadena de suministro y menos retrasos. “Hecho en Europa” no es solo un lugar: es nuestro compromiso con la responsabilidad, la conexión y la calidad.

# LET'S START FROM THE SOURCE

---

**Sustainability begins with the materials we choose.  
Some may surprise you, but true commitment means thinking creatively.**

**Here are some examples:**

- Made from scrap fruit and veg trays
- Made from pharmaceutical waste
- Made from recycled car parts

**Our Ecolutions® range includes:**

- Recycled and recyclable materials
- Biobased materials
- FSC-certified paper from sustainable forests
- Recycled-paper packaging

## FR COMMENÇONS À LA SOURCE

La durabilité commence par les matériaux que nous choisissons. Certains vous surprendront peut-être, mais un véritable engagement implique de faire preuve de créativité.

En voici quelques exemples:

- Fabriqué à partir de déchets de barquettes de fruits et légumes
- Fabriqué à partir de déchets pharmaceutiques
- Fabriqué à partir de déchets de pièces automobiles en plastique

Notre gamme Ecolutions® est fabriquée à partir de matériaux durables

- Matériaux recyclés et recyclables
- Matériaux biosourcés
- Papier issu de forêts durables (FSC)
- Emballage en papier recyclé

## IT TORNIAMO ALL'ORIGINE

La sostenibilità inizia dai materiali che scegliamo. Alcuni vi sorprenderanno, ma un vero impegno significa pensare in modo creativo.

Ecco alcuni esempi:

- Prodotti con scarti di vassoi di frutta e verdura
- Prodotti con rifiuti farmaceutici
- Prodotti con scarti di plastica provenienti da automobili

La nostra gamma Ecolutions® è realizzata con materiali sostenibili

- Materiali riciclati e riciclabili
- Materiali biobased
- Carta proveniente da foreste sostenibili (FSC)
- Imballaggio in carta riciclata

## DE NACHHALTIGKEIT BEGINNT SCHON AM URSPRUNG

Nachhaltigkeit beginnt bei den Materialien, die wir auswählen. Einige werden Sie vielleicht überraschen, aber echtes Engagement bedeutet, kreativ zu denken.

Hier sind einige Beispiele:

- Hergestellt aus Obst- und Gemüseverpackungen
- Hergestellt aus pharmazeutischen Abfällen
- Hergestellt aus den Resten von Plastikautoteilen

Unser Ecolutions®-Sortiment wird aus nachhaltigen Materialien hergestellt

- Recycelte und wiederverwertbare Materialien
- Biobasierte Materialien
- Papier aus nachhaltiger Forstwirtschaft (FSC)
- Verpackung aus recyceltem Papier

## ES EMPECEMOS POR EL PRINCIPIO

La sostenibilidad empieza por los materiales que elegimos. Algunos pueden sorprenderle, pero el verdadero compromiso implica pensar de forma creativa.

He aquí algunos ejemplos:

- Fabricado con restos de bandejas de frutas y verduras
- Fabricado a partir de residuos farmacéuticos
- Fabricado con restos de piezas de plástico de coches

Nuestra gama Ecolutions® está fabricada con materiales sostenibles

- Materiales reciclados y reciclables
- Materiales biológicos
- Papel procedente de bosques sostenibles (FSC)
- Envases de papel reciclado



MADE IN SPAIN

Made from scrap plastic car parts.

**BIC® MEDIA CLIC GRIP ECOLUTIONS®**



**BIC® MEDIA CLIC ECOLUTIONS®**



**BIC® SUPER CLIP ECOLUTIONS®**



MADE IN SPAIN

Made from sugar cane.

**BIC® MEDIA CLIC BIOBASED ECOLUTIONS®**



FSC and recyclable cardboard.

**SPROUT™ graphite pencil**



FABRIQUÉ EN FRANCE  
MADE IN FRANCE

Made from recycled fridges and yogurt pots.

**BIC® EVOLUTION® ECOLUTIONS®**



**BIC® KIDS EVOLUTION® ECOLUTIONS® COLOURING SET**



FABRIQUÉ EN FRANCE  
MADE IN FRANCE

Made from pharmaceutical waste.

**BIC® PERMANENT MARKER ECOLUTIONS®**



**BIC® MATIC® ECOLUTIONS®**



MADE IN SPAIN

Made from biobased material.

**BIC® SUPER CLIP ORIGIN**



MADE IN SPAIN

Made from scrap fruit and vegetables trays.

**BIC® WIDE BODY™ ECOLUTIONS®**



**BIC® CLIC STIC ECOLUTIONS®**



**BIC® ROUND STIC® ECOLUTIONS®**



# A pen that connects generations

Legend has it that some stories are meant to intertwine. The BIC® Cristal® is one of those stories, destined to inspire creativity and connect generations. Born from the vision of Marcel Bich in 1950, this simple yet revolutionary pen has shaped lives and sparked creativity across the globe.

Over the years, the iconic BIC® Cristal® has travelled the world, found its place in your pocket, schoolchildren's pencil cases, on your father's desk, and even at the till in your local bakery.

## FR UN STYLO QUI RELIE LES GÉNÉRATIONS

La légende dit que certaines histoires sont faites pour s'entrelacer. Le BIC® Cristal® est l'une de ces histoires, destinée à inspirer la créativité et à relier les générations. Né de la vision de Marcel Bich en 1950, ce stylo simple mais révolutionnaire a façonné des vies et éveillé la créativité à travers le monde. Au fil des années, l'émblématique BIC® Cristal® a parcouru le monde, trouvé sa place dans votre poche, dans les trousseaux d'écoliers, sur le bureau de votre père, et même à la caisse de votre boulangerie locale.

## IT UNA PENNA CHE COLLEGA LE GENERAZIONI

La leggenda narra che alcune storie sono destinate a intrecciarsi. La BIC® Cristal® è una di queste storie, creata per ispirare la creatività e unire le generazioni. Nata dalla visione di Marcel Bich nel 1950, questa penna semplice ma rivoluzionaria ha plasmato vite e acceso la creatività in tutto il mondo. Nel corso degli anni, l'iconica BIC® Cristal® ha girato il mondo, trovando posto nella tua tasca, negli astucci dei bambini, sulla scrivania di tuo padre e persino alla cassa del tuo panificio locale.

## DE EIN KUGELSCHREIBER, DER GENERATIONEN VERBINDET

Der Legende nach sind manche Geschichten dazu bestimmt, sich zu verweben. Der BIC® Cristal® ist eine dieser Geschichten, geschaffen, um Kreativität zu inspirieren und Generationen zu verbinden. Aus der Vision von Marcel Bich im Jahr 1950 geboren, hat dieser einfache, aber revolutionäre Kugelschreiber das Leben geprägt und Kreativität auf der ganzen Welt entfacht. Im Laufe der Jahre hat der legendäre BIC® Cristal® die Welt bereist, seinen Platz in Ihrer Tasche, in den Federmäppchen von Schulkindern, auf dem Schreibtisch Ihres Vaters und auch an der Kasse Ihrer örtlichen Bäckerei gefunden.

## ES UN BOLÍGRAFO QUE CONECTA GENERACIONES

La leyenda dice que algunas historias están destinadas a entrelazarse. El BIC® Cristal® es una de esas historias, creada para inspirar creatividad y conectar generaciones. Nacido de la visión de Marcel Bich en 1950, este bolígrafo simple pero revolucionario ha moldeado vidas y desatado creatividad en todo el mundo. A lo largo de los años, el icónico BIC® Cristal® ha viajado por el mundo, encontrando su lugar en tu bolsillo, en los estuches de los alumnos, en el escritorio de tu padre e incluso en la caja de tu panadería local.

# A Timeless Storyteller

**75<sup>TH</sup>**  
ANNIVERSARY OF THE BIC® CRISTAL®

Since 1950, the BIC® Cristal® has been more than just a writing tool; its iconic design has told stories of life, progress and creativity, helping people from various generations and cultures express themselves. Guided by Marcel Bich's vision of providing an affordable, high-quality pen, the Cristal® has witnessed cultural revolutions, artistic movements and business innovations, remaining a symbol of innovation, precision and connection while staying true to its purpose of bringing people together.

And the story is not over.

FR  
**UN CONTEUR INTEMPOREL**

Depuis 1950, le BIC® Cristal® est bien plus qu'un outil d'écriture; son design emblématique a raconté des histoires de vie, de progrès et de créativité, aidant des générations et des cultures variées à s'exprimer. Guidé par la vision de Marcel Bich de fournir un stylo abordable et de haute qualité, le BIC® Cristal® a été témoin de révolutions culturelles, de mouvements artistiques et d'innovations commerciales. Il demeure un symbole d'innovation, de précision et de connexion tout en restant fidèle à son objectif: rapprocher les gens.

IT  
**UN NARRATORE SENZA TEMPO**

Dal 1950, la BIC® Cristal® è molto più di un semplice strumento di scrittura; il suo design iconico ha raccontato storie di vita, progresso e creatività, aiutando persone di generazioni e culture diverse a esprimersi. Guidata dalla visione di Marcel Bich di offrire una penna accessibile e di alta qualità, la Cristal® è stata testimone di rivoluzioni culturali, movimenti artistici e innovazioni aziendali. Rimane un simbolo di innovazione, precisione e connessione, rimanendo fedele al suo scopo di avvicinare le persone.

DE  
**EIN ZEITLOSER ERZÄHLER**

Seit 1950 ist der BIC® Cristal® mehr als nur ein Schreibgerät; sein legendäres Design erzählt Geschichten von Leben, Fortschritt und Kreativität und hilft Menschen aus verschiedenen Generationen und Kulturen, sich auszudrücken. Geleitet von Marcel Bich's Vision, einen erschwinglichen, hochwertigen Kugelschreiber anzubieten, war der BIC® Cristal® Zeuge kultureller Revolutionen, künstlerischer Bewegungen und geschäftlicher Innovationen. Er bleibt ein Symbol für Innovation, Präzision und Verbindung, während er seinem Ziel treu bleibt, Menschen zusammenzubringen.

ES  
**UN NARRADOR ATEMPORAL**

Desde 1950, el BIC® Cristal® ha sido mucho más que una herramienta de escritura; su diseño icónico ha contado historias de vida, progreso y creatividad, ayudando a personas de diversas generaciones y culturas a expresarse. Guiado por la visión de Marcel Bich de proporcionar un bolígrafo accesible y de alta calidad, el BIC® Cristal® ha sido testigo de revoluciones culturales, movimientos artísticos e innovaciones empresariales. Sigue siendo un símbolo de innovación, precisión y conexión, manteniéndose fiel a su propósito de unir a las personas.

# BIC® CRISTAL® EXPRESSION



What started as a simple tool for expression has now become an expression in itself. Thanks to advanced digital printing technology, we've transformed the iconic BIC® Cristal® into a canvas for unique branding opportunities. Now, businesses, cultural institutions and cities can personalise the iconic BIC® Cristal® to empower their stories and build lasting connections.

Writes up to  
**3km**



BRITEPIX™ DIGITAL  
Full colour possibilities  
and large printing areas.



FABRIQUÉ  
EN FRANCE   
MADE IN FRANCE

FR

## BRAND AN ICON - BIC® CRISTAL® EXPRESSION

Ce qui a commencé comme un simple outil d'expression est aujourd'hui devenu une expression en soi. Grâce à une technologie d'impression numérique avancée, nous avons transformé l'icône BIC® Cristal® en une toile pour des opportunités de marque uniques. Désormais, les entreprises, les institutions culturelles et les villes peuvent personnaliser le BIC® Cristal® pour donner vie à leurs histoires et établir des connexions durables.

IT

## BRAND AN ICON - BIC® CRISTAL® EXPRESSION

Quello che è nato come un semplice strumento per l'espressione è ora diventato un'espressione di per sé. Grazie alla tecnologia avanzata di stampa digitale, abbiamo trasformato l'iconica BIC® Cristal® in una tela per opportunità di branding uniche. Ora, aziende, istituzioni culturali e città possono personalizzare la leggendaria BIC® Cristal® per rafforzare le loro storie e creare connessioni durature.

DE

## BRAND AN ICON - BIC® CRISTAL® EXPRESSION

Was als einfaches Schreibgerät zur Selbstentfaltung begann, ist nun selbst Mittel zum Ausdruck geworden. Dank fortschrittlicher digitaler Drucktechnologie haben wir den legendären BIC® Cristal® in eine Leinwand für einzigartige Branding-Möglichkeiten verwandelt. Unternehmen, kulturelle Institutionen und Städte können jetzt den legendären BIC® Cristal® personalisieren, um ihre Geschichten zu stärken und dauerhafte Beziehungen aufzubauen.

ES

## BRAND AN ICON - BIC® CRISTAL® EXPRESSION

Lo que comenzó como una herramienta sencilla para la expresión se ha convertido ahora en una expresión en sí misma. Gracias a la avanzada tecnología de impresión digital, hemos transformado el icónico BIC® Cristal® en un lienzo para oportunidades únicas de marca. Ahora, empresas, instituciones culturales y ciudades pueden personalizar el icónico BIC® Cristal® para dar fuerza a sus historias y construir conexiones duraderas.

# Brand an icon



 **BIC**  
**Cristal**  
**expression**

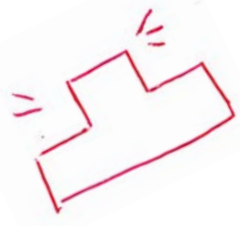
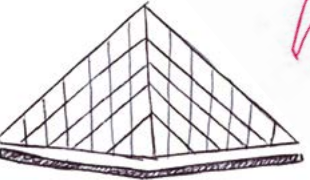
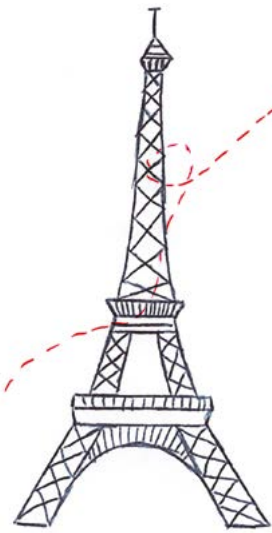

**BIC® MEDIA CLIC BIOBASED ECOLUTIONS®**

# NEW PASTEL COLOURS!

Style is neither created nor destroyed, it is transformed.  
And so it is with our bestseller, now with new colour  
options that give it a special, contemporary touch.



MADE FROM  
**69% BIO-SOURCED\***  
MATERIAL



MADE  
IN SPAIN

FR

## NOUVELLES COULEURS PASTEL!

Le style ne se crée ni ne se détruit, il se transforme.  
Et c'est le cas de notre best-seller, désormais disponible  
dans de nouvelles options de couleurs qui lui apportent  
une touche spéciale et contemporaine.

IT

## NUOVI COLORI PASTELLO!

Lo stile non si crea né si distrugge, si trasforma.  
Ed è così anche per il nostro best-seller, ora con nuove  
opzioni di colore che gli conferiscono un tocco speciale  
e contemporaneo.

DE

## NEUE PASTELLFARBEN!

Stil wird weder erschaffen noch zerstört, er wird  
verwandelt. So ist es auch mit unserem Bestseller,  
jetzt mit neuen Farboptionen, die ihm einen  
besonderen, zeitgemäßen Touch verleihen.

ES

## ¡NUEVOS COLORES PASTEL!

El estilo no se crea ni se destruye, se transforma.  
Y así ocurre con nuestro éxito de ventas, ahora con  
nuevas opciones de colores que le dan un toque  
especial y contemporáneo.

Cozy Blue



Peaceful Pink



Inspiring Autumn





**Evolution**  
**ecolutions**

**BIC® KIDS EVOLUTION® COLOURING SET**

# Forever Kids

## Safe, Fun Colouring for Kids!

Our ultra-resistant, wood-free pencils are the perfect choice for everyday drawing and colouring. They're super easy to sharpen, splinter-free, and safe to use—even if they get chewed on!

The ultimate companion for your little ones' creativity!



MADE FROM  
**51% RECYCLED  
MATERIAL\***



FRIDGES AND  
YOGURT POTS



SAFE USAGE  
FOR KIDS



### FR RESTER TOUJOURS ENFANTS

Un coloriage sûr et amusant pour les enfants !  
Nos crayons ultra-résistants, sans bois, sont le choix idéal pour le dessin et le coloriage au quotidien. Ils sont très faciles à tailler, sans éclats, et sûrs à utiliser—même s'ils sont mâchouillés !  
Le compagnon idéal pour la créativité de vos petits artistes !

### IT PER SEMPRE BAMBINI

Colorare in sicurezza e con divertimento per bambini!  
Le nostre matite ultra-resistenti, senza legno, sono la scelta perfetta per disegnare e colorare ogni giorno. Sono facilissime da temperare, senza schegge, e sicure da usare—anche se vengono mordicchiate!  
Il compagno ideale per la creatività dei vostri piccoli!

### DE FÜR IMMER KINDER

Sicheres, spaßiges Malen für Kinder!  
Unsere ultra-robusten, holzfreien Buntstifte sind die perfekte Wahl für den täglichen Mal- und Zeichenbedarf. Sie sind super leicht anzuspitzen, splitterfrei und sicher zu benutzen—auch wenn darauf gekaut wird!  
Der ultimative Begleiter für die Kreativität der Kleinen!

### ES PARA SIEMPRE NIÑOS

¡Colorear seguro y divertido para niños!  
Nuestros lápices ultrarresistentes y sin madera son la opción perfecta para dibujar y colorear a diario. Son súper fáciles de afilar, sin astillas y seguros de usar—¡Incluso si los muerden!  
El compañero ideal para la creatividad de tus pequeños artistas.

NEW



GENERAL INFORMATION

BIC® PACKAGING

BIC® / DEEP® LIGHTERS AND BIC® CASES

NOTEBOOKS

OTHER WRITING INSTRUMENTS

BIC® WRITING INSTRUMENTS

BIC GRAPHIC



**BIC® EZ REACH™**

# LIGHT UP UNIQUE MOMENTS



Safe flame occasions are endless with the new **BIC® EZ Reach™**



**The most amazing moments begin when someone lights the flame.**



## **Safety Flame.**

- Helps keep fingers away from the flame

### FR **ILLUMINEZ VOS MOMENTS UNIQUES**

Les occasions avec une flamme sûre sont infinies avec le nouveau BIC® EZ Reach™.

#### **Flamme sûre**

- Aide à garder les doigts éloignés de la flamme.

### IT **ILLUMINA I MOMENTI UNICI**

Le occasioni con una fiamma sicura sono infinite con il nuovo BIC® EZ Reach™.

#### **Fiamma sicura**

- Aiuta a mantenere le dita lontane dalla fiamma.

### DE **ENTFACHEN SIE EINZIGARTIGE MOMENTE**

Die Möglichkeiten mit einer sicheren Flamme sind endlos mit dem neuen BIC® EZ Reach™.

#### **Sichere Flamme**

- Hilft die Finger von der Flamme fernzuhalten.

### ES **ILUMINA MOMENTOS ÚNICOS**

Las ocasiones con una llama segura son infinitas con el nuevo BIC® EZ Reach™.

#### **Llama segura**

- Ayuda a mantener los dedos alejados de la llama.

NEW!



GENERAL INFORMATION

BIC® PACKAGING

BIC® / D/EEP® LIGHTERS AND BIC® CASES

NOTEBOOKS

OTHER WRITING INSTRUMENTS

BIC® WRITING INSTRUMENTS

BIC GRAPHIC

# A set of BIC® products in customisable boxes

You can go even further in customisation with our FSC cardboard box, customisable on each side. Perfect for combining our iconic BIC® products as a set. A great way to maximise your sales!



FSC AND RECYCLABLE  
CARDBOARD



MADE IN  
EUROPE

**100%**  
*Customisable!*

FR

## UN ENSEMBLE DE PRODUITS BIC® DANS DES BOÎTES PERSONNALISABLES

Vous pouvez aller encore plus loin dans la personnalisation avec notre boîte en carton FSC, personnalisable sur chaque face. Idéal pour proposer nos produits iconiques BIC® à travers une collection. Une excellente façon de maximiser vos ventes!

Carton FSC et recyclable / Fabriqué en Europe / 100% personnalisable

IT

## UN SET DI PRODOTTI BIC® IN CONFEZIONI PERSONALIZZABILI

Si può andare persino oltre nella personalizzazione grazie alla nostra confezione in cartone FSC, personalizzabile su ogni lato. Perfetta per creare un set dei nostri iconici prodotti BIC®. Un ottimo modo per massimizzare le tue vendite!

Cartone FSC e riciclabile / Prodotto in Europa / 100% personalizzabile

DE

## EIN BIC®-PRODUKTE-SET IN INDIVIDUELL GESTALTbaren VERPACKUNGEN

Auf unseren Verpackungen aus FSC-Karton, die man auf jeder Seite individuell gestalten kann, können Sie sogar noch mehr Werbebotschaften unterbringen. Sie sind ideal, um unsere kultigen BIC®-Produkte als Set zusammenzustellen. Eine großartige Möglichkeit, Ihre Verkäufe zu maximieren!

FSC-zertifizierter und recycelbarer Karton / Hergestellt in Europa / 100% personalisierbar

ES

## UN JUEGO DE PRODUCTOS BIC® EN CAJAS PERSONALIZABLES

Puedes ir aún más lejos en la personalización con nuestra caja de cartón FSC, personalizable por cada lado. Perfecto para combinar nuestros icónicos productos BIC® en un juego. Una excelente forma de maximizar tus ventas!

Cartón FSC y reciclable / Fabricado en Europa / 100% customizable

SPECIAL PACKAGING FOR:

**BIC® Cristal® Expression**  
**BIC® Round Stic®**  
**BIC® Style**  
**BIC® Clic Stic**

BIC® COLLECTION  
BOX SLIM PENS  
4 UNITS  
529294

**NEW!**



SPECIAL PACKAGING FOR:

**BIC® 4 Colours®**  
**BIC® Wide Body™**  
**BIC® Super Clip**  
**BIC® Brite Liner® Grip**  
**BIC® Grip Roller**

BIC® COLLECTION BOX  
1 UNIT  
991212

BIC® COLLECTION BOX  
2 UNITS  
991213

BIC® COLLECTION BOX  
3 UNITS  
991214



BIC  
GRAPHIC

BIC®  
WRITING INSTRUMENTS

OTHER WRITING  
INSTRUMENTS

NOTEBOOKS

BIC® / DLEEP® LIGHTERS  
AND BIC® CASES

BIC®  
PACKAGING

GENERAL  
INFORMATION

Contents

**BIC<sup>®</sup>**  
**WRITING**  
**INSTRUMENTS**

---

**01**

## BALLPENS

BIC® Cristal® Expression	40
BIC® Cristal® Re'New™	44
BIC® Style	48
BIC® Round Stic®	52
BIC® Round Stic® BGuard™ antibacterial	54
BIC® Round Stic® Ecolutions®	55
BIC® M10® Clic	58
BIC® Media Clic	62
BIC® Media Clic Ecolutions®	63
BIC® Media Clic Grip	65
BIC® Media Clic Grip Ecolutions®	66
BIC® Media Clic BGuard™ antibacterial	72
BIC® Media Clic BGuard™ antimicrobial Ecolutions®	74
BIC® Media Clic Biobased Ecolutions®	76
BIC® Media Clic Biobased BGuard™ antibacterial	80
BIC® Media Clic Shine	82
BIC® Media Clic Glacé	84
BIC® Clic Stic	86
BIC® Clic Stic Ecolutions®	87
BIC® Clic Stic Stylus	90
BIC® Clic Stic Stylus Ecolutions®	90
BIC® Super Clip	96
BIC® Super Clip Ecolutions®	97
BIC® Super Clip Advance	100
BIC® Super Clip Glacé	104
BIC® Super Clip Glacé Advance	104
BIC® Super Clip Soft	106
BIC® Super Clip Soft Advance	106
BIC® Super Clip Origin	108
BIC® Wide Body™	112
BIC® Wide Body™ Ecolutions®	113
BIC® 4 Colours®	120
BIC® 4 Colours® Rainbow Decor	122
BIC® 4 Colours® Bicolor	124
BIC® 4 Colours® Gradient	126
BIC® 4 Colours® Pastel	128
BIC® 4 Colours® Fashion	130
BIC® 4 Colours® Sun	132
BIC® 4 Colours® Fine	134

BIC® 4 Colours® Fluo	136
BIC® 4 Colours® Glacé	138
BIC® 4 Colours® Shine	140
BIC® 4 Colours® Soft	142
BIC® 4 Colours® Wood Style	144
BIC® 4 Colours® Flags Collection	146
BIC® 4 Colours® 3+1 <sup>HB</sup>	148

## METALLIC PENS

BIC® Metal Pro	150
----------------	-----

## ROLLERS AND GELS

BIC® Grip Roller	156
BIC® XS Finestyle	158
BIC® Intensity® Gel Clic	160

## HIGHLIGHTERS AND MARKERS

BIC® Brite Liner® Grip	164
BIC® Velleda® White Board Marker Fine	166
BIC® Velleda® White Board Marker Grip	167
BIC® Mark-It Permanent Marker	168
BIC® Permanent Marker Ecolutions®	169

## MECHANICAL PENCILS

BIC® Matic®	172
BIC® Matic® Ecolutions®	172
BIC® Media Clic Mechanical pencil	174
BIC® Media Clic Grip Mechanical pencil	175
BIC® Media Clic Grip Mechanical pencil Ecolutions®	175

## PENCILS

BIC® Evolution® Ecolutions®	180
BIC® Kids Evolution® Colouring Set	184
Sprout™ Graphite pencil	186

# BIC® CRISTAL® EXPRESSION

## Brand an Icon.

Experience the evolution of the iconic BIC® Cristal® with BIC® Cristal® Expression. This classic pen now combines timeless design with cutting-edge BritePix™ digital printing technology, offering unique personalisation.



FR

### Brand an Icon.

Découvrez l'évolution du célèbre BIC® Cristal® avec le BIC® Cristal® Expression. Ce stylo classique allie désormais un design intemporel à la technologie d'impression numérique de pointe BritePix™, offrant ainsi une personnalisation unique.

IT

### Brand an Icon.

Scopri l'evoluzione dell'iconico BIC® Cristal® con il BIC® Cristal® Expression. Questa penna classica unisce ora un design senza tempo alla avanzata tecnologia di stampa digitale BritePix™, offrendo una personalizzazione unica.

DE

### Brand an Icon.

Erleben Sie die Evolution des legendären BIC® Cristal® mit dem BIC® Cristal® Expression. Dieser klassische Kugelschreiber vereint nun zeitloses Design mit der hochmodernen BritePix™ Digitaldrucktechnologie und bietet einzigartige Personalisierungsmöglichkeiten.

ES

### Brand an Icon.

Experimenta la evolución del icónico BIC® Cristal® con el BIC® Cristal® Expression. Este bolígrafo clásico ahora combina un diseño atemporal con la avanzada tecnología de impresión digital BritePix™, ofreciendo una personalización única.



**BIC® CRISTAL® EXPRESSION**

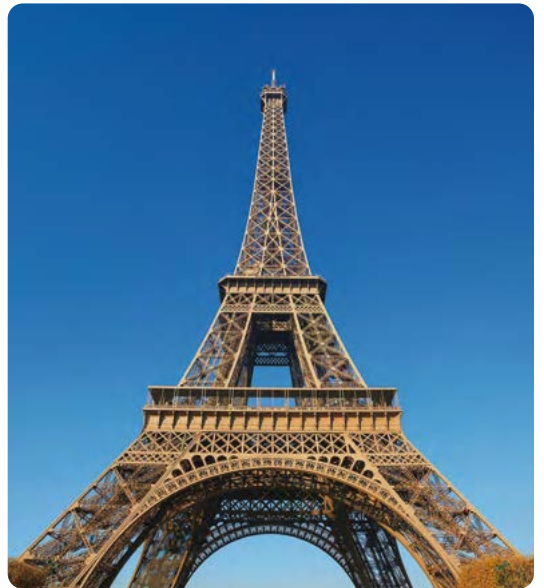
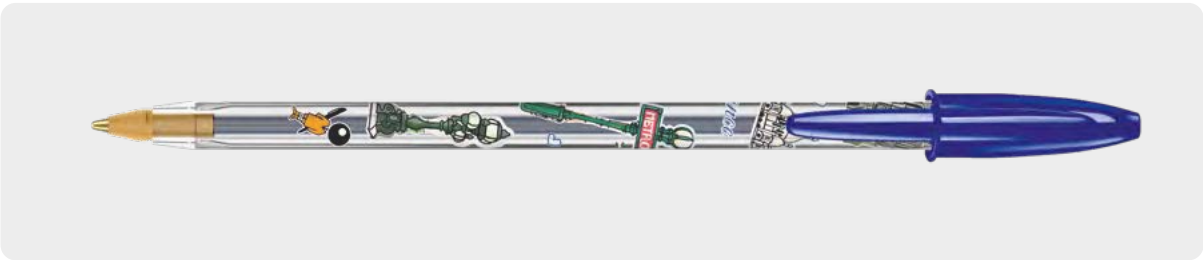

# Iconic object of design

1095

BIC® CRISTAL®  
EXPRESSION

1095

Colour ink



NEW!



02



03



05



04

100%

FR  
Objet emblématique  
du design

DE  
Legendäres  
Designobjekt

IT  
Oggetto iconico  
di design

ES  
Objeto icónico  
del diseño

1095

**BIC® CRISTAL® EXPRESSION**

1095

A BP: BritePix™ Digital

MOQ 250 units

**Decoration**

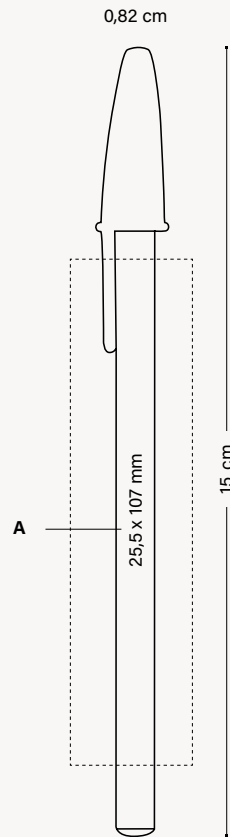

**OPTIONAL SPECIAL PACKAGING**



BIC COLLECTION  
BOX SLIM PENS

*New!*

+ INFO PAGES 262 TO 266

**EXTERNAL PACKAGING**



WRITING  
MODES



PRINTING  
TECHNIQUES



BRITEPIX™ DIGITAL

SUSTAINABILITY



BIC  
GRAPHIC

BIC®  
WRITING INSTRUMENTS

OTHER WRITING  
INSTRUMENTS

NOTEBOOKS

BIC® / DLEEP® LIGHTERS  
AND BIC® CASES

BIC®  
PACKAGING

GENERAL  
INFORMATION

See pages 274-277 for a detailed explanation of the icons

# BIC® CRISTAL® RE'NEW™

## The iconic BIC® Cristal® in a metal version.

The BIC® Cristal® Re'New™ adds to the iconic BIC® Cristal® original, attaching a sense of modernity to its aluminum matt barrel and the laser engraved BIC® logo. The cap has been also redesigned; it's matt grey and manufactured from 96% recycled plastic. Refillable with blue or black inks. Includes 2 cartridges.

FR

### L'icone BIC® Cristal® version métallique.

Le nouveau BIC® Cristal® Re'New™ reprend le design de l'icone BIC® Cristal® Original et ajoute une touche de modernité grâce à son corps au rendu aluminium mat et l'inscription au laser du logo BIC®. Le capuchon a été également redessiné: il est gris mat et fabriqué à partir de plastique recyclé à 96%. Rechargeable à encre bleue ou noire avec 2 recharges incluses.

IT

### L'iconica BIC® Cristal® in versione metallica.

Il nuovo BIC® Cristal® Re'New™ riprende il design dell'iconico BIC® Cristal® Original e aggiunge un tocco di modernità grazie al corpo in alluminio opaco e all'iscrizione al laser del logo BIC®. Anche il cappuccio è stato ridisegnato: è grigio opaco e realizzato con plastica riciclata al 96%. Ricaricabile con inchiostro blu o nero con 2 ricariche incluse.

DE

### Der legendäre BIC® Cristal® in einer Metallversion.

Der BIC® Cristal® Re'New™ erweitert den klassischen BIC® Cristal® und verleiht ihm mit seinem mattierten Aluminiumgehäuse und dem lasergravierten BIC®-Logo einen modernen Touch. Die zwei Nachfüllminen im Lieferumfang sorgen dafür, dass Ihnen über sehr lange Zeit nicht die Tinte ausgeht. Der Kugelschreiber hat einen langlebigen, matt-silbernen Metallschaft und eine dazu passende Kappe aus 96 % recyceltem Kunststoff.

ES

### El icónico BIC® Cristal® original en versión metal.

El nuevo BIC® Cristal® Re'New™ añade al icónico BIC® Cristal® original un toque de modernidad con su cuerpo de aluminio mate y el logotipo BIC® grabado con láser. El capuchón también ha sido rediseñado: es gris mate y está fabricado con un 96% de plástico reciclado. Recargable, con tintas azul o negra. Incluye 2 cartuchos.

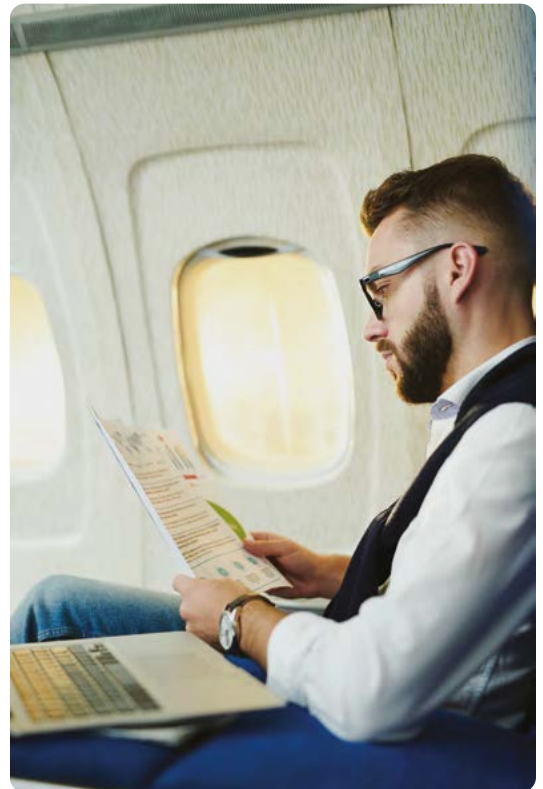

**BIC® CRISTAL® RE'NEW™**



# Elegance dressed in metal.

1090

BIC® CRISTAL®  
RE'NEW™

1090

Colour ink



BIC® WINDOW BOX

1 pen + 2 refills

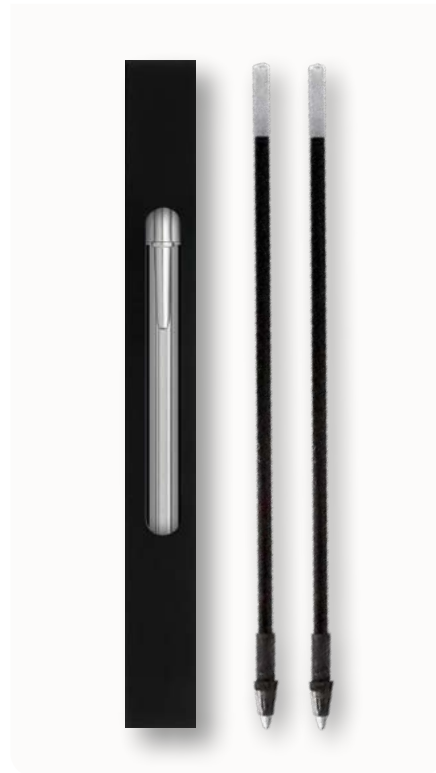

*Your Cristal® Re'New™  
comes with this packaging!*

(Included in the price)

FR  
**L'élégance vêtue  
de métal.**

DE  
**Eleganz in Metall  
gekleidet.**

IT  
**Eleganza vestita  
di metallo.**

ES  
**Elegancia  
vestida de metal.**

1090

**BIC® CRISTAL® RE'NEW™**

1090

A LE: max. 1 col.

MOQ 25 units

**Decoration**

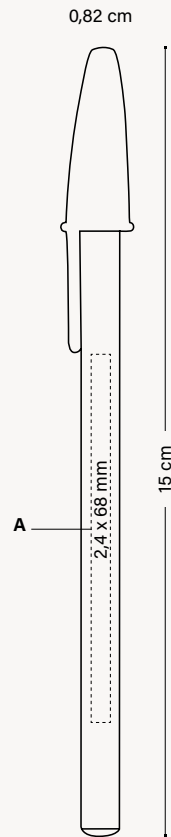

**EXTERNAL PACKAGING**



MANUFACTURED AND PRINTED IN BIC FACTORIES



REGULATORY COMPLIANCE



ISO certified

WRITING MODES



BALLPEN M  
0.1 MM

PRINTING TECHNIQUES



LE  
LASER

SUSTAINABILITY



IMPRIM'VERT®



REFILLABLE

---

BIC® STYLE

# Globally renowned BIC® cap design.

The BIC® Style offers excellent  
value for money.



FR

**Facilement reconnaissable  
dans le monde entier grâce à  
son capuchon emblématique.**

Le BIC® Style offre un excellent rapport  
qualité-prix.

IT

**Riconoscibile facilmente  
grazie al suo tappo iconico.**

BIC® Style offre un eccellente  
rapporto qualità-prezzo.

DE

**Weltweit leicht an der  
legendären Kappe zu erkennen.**

Der BIC® Style bietet ein  
hervorragendes Preis-Leistungs-  
Verhältnis.

ES

**Reconocido mundialmente  
por su icónico capuchón.**

El BIC® Style ofrece una excelente  
relación calidad precio.

1610

**BIC® STYLE**  
1610 Opaque

Colour ink  
● ●



01/01

01/03

01/04

01/02

02/02

04

10

●  
Only available  
in black ink

●  
Only available  
in blue ink

●  
Only available  
in black ink

  
MANUFACTURED  
AND PRINTED IN  
BIC FACTORIES

  
REGULATORY  
COMPLIANCE

  
ISO  
certified

**WRITING  
MODES**

  
BALLPEN M  
0.1 MM

**PRINTING  
TECHNIQUES**

  
SP  
SCREEN PRINTING

**SUSTAINABILITY**

  
IMPRIM'VERT®

  
100% ELECTRICITY COMING  
FROM RENEWABLE SOURCES

See pages 274-277 for a detailed explanation of the icons

1610

**BIC® STYLE**  
1610 Clear

Colour ink



1610

**BIC® STYLE**

1610 Opaque  
A SP: max. 1 col.

**BIC® STYLE**

1610 Clear  
B SP: max. 1 col.

MOQ 500 units

Decoration

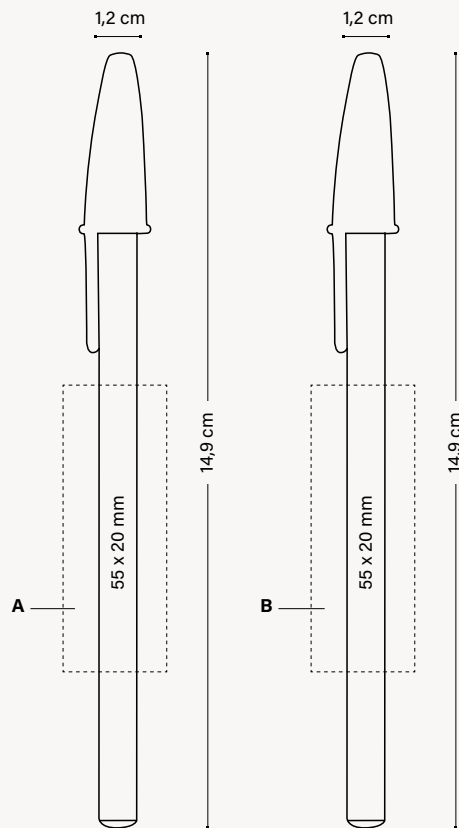

WRITING MODES



PRINTING TECHNIQUES



SUSTAINABILITY



OPTIONAL SPECIAL PACKAGING



Can be used as bookmark

BIC COLLECTION BOX SLIM PENS

New!

+ INFO PAGES 262 TO 266

EXTERNAL PACKAGING



See pages 274-277 for a detailed explanation of the icons

BIC GRAPHIC

BIC WRITING INSTRUMENTS

OTHER WRITING INSTRUMENTS

NOTEBOOKS

BIC / DLEEP® LIGHTERS AND BIC® CASES

BIC® PACKAGING

GENERAL INFORMATION

---

BIC® ROUND STIC®

# The iconic BIC® Round Stic® offers a timeless style and high quality.

Its classic design is easy  
to identify and symbolises  
long-term reliability.



FR

**L'iconique BIC® Round Stic®  
offre un style indémodable  
et une très grande qualité.**

Son design classique est facile à  
identifier et il est synonyme de fiabilité  
à long terme.

IT

**L'iconica BIC® Round Stic®  
offre uno stile intramontabile  
ed alta qualità.**

Il suo design classico la rende  
facilmente riconoscibile ed è prova  
di una longeva affidabilità.

DE

**Unser legendärer BIC® Round  
Stic® bietet zeitloses Design  
in hoher Qualität.**

Sein klassisches Design ist einfach  
zu erkennen und steht für lang  
anhaltende Zuverlässigkeit.

ES

**El icónico BIC® Round Stic®  
ofrece un estilo atemporal  
y una alta calidad.**

Su diseño clásico se identifica  
fácilmente y simboliza la fiabilidad  
a largo plazo.

1010

**BIC® ROUND STIC®**  
1010 Opaque

Colour ink  
● ● ●

*Red Ink available under request*



*Embossed  
iconic BIC® brand!*



12



05



07



18



02



03



100%

*Only available  
on white barrel*



**MIX &  
MATCH**



PERSONALIZED  
COLOURS



MANUFACTURED  
AND PRINTED IN  
BIC FACTORIES



MADE  
IN SPAIN



REGULATORY  
COMPLIANCE



ISO  
certified

**WRITING  
MODES**



BALLPEN M  
0.1 MM

**PRINTING  
TECHNIQUES**



SP  
SCREEN PRINTING



DG  
DIGITAL

**SUSTAINABILITY**



IMPRIM'VEERT®



100% ELECTRICITY COMING  
FROM RENEWABLE SOURCES

See pages 274-277 for a detailed explanation of the icons



1010

**BIC® ROUND STIC®**  
1010 Frosted

Colour ink



Red Ink available under request



69      63      71      66      67      40      68

1011

**BIC® ROUND STIC® BGUARD™**  
**ANTIBACTERIAL**  
1011 Opaque

Colour ink



Red Ink available under request

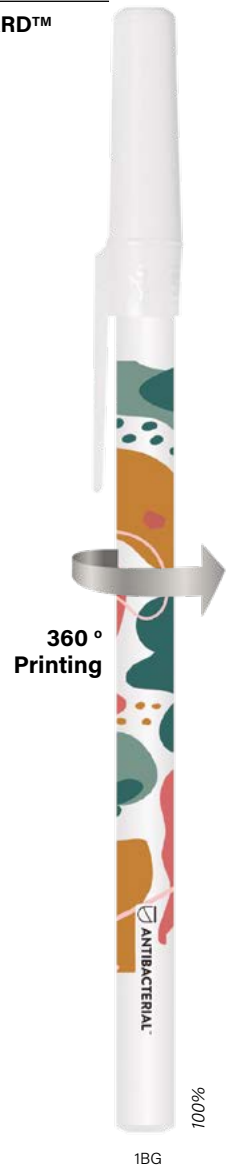

1BG

Only available on white barrel



ECO version and standard at the same price!

**ecolutions®**



MADE FROM **98% RECYCLED MATERIAL\***  
\*Excluding ink system

FRUIT AND VEGETABLE TRAYS



**MIX & MATCH**



PERSONALIZED COLOURS



MANUFACTURED AND PRINTED IN BIC FACTORIES



MADE IN SPAIN



REGULATORY COMPLIANCE



ISO certified

WRITING MODES



BALLPEN M Ø 1 MM

PRINTING TECHNIQUES



SCREEN PRINTING



DIGITAL

SUSTAINABILITY



IMPRIM'VERT®

**ecolutions®**



FRUIT AND VEGETABLE TRAYS



100% ELECTRICITY COMING FROM RENEWABLE SOURCES

1E10

**BIC® ROUND STIC®**  
1E10 Opaque

Colour ink



Red Ink available under request



1E/8E

1E/7E

1E/3E

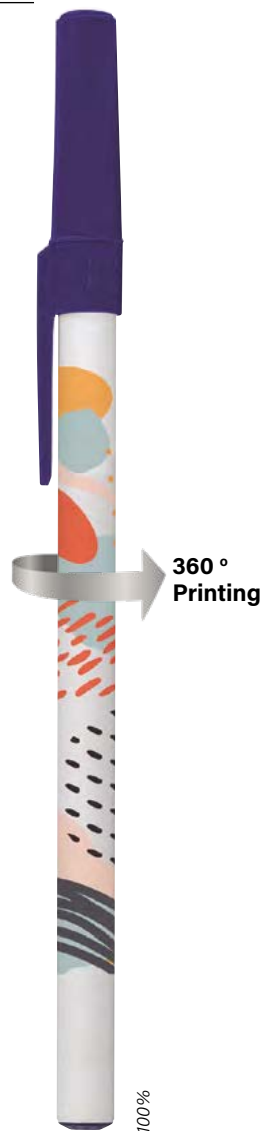

360° Printing

100%

Only available on white barrel



1E10

**BIC® ROUND STIC®**  
1E10 Frosted

Colour ink



Red Ink available under request



2E/8E

2E/7E

2E/3E

2E/10E

100%

See pages 274-277 for a detailed explanation of the icons

\*The percentage is calculated based on total weight of the product excluding ink system. Due to the recycled content of the raw materials used to make the pen, we cannot guarantee that the colours shown in the catalogue or colours customised to order will always have the same colour and appearance.

# BIC® ROUND STIC®

1010 / 1E10 / 1011

## BIC® ROUND STIC®

1010 / **ecolutions®** 1E10 Opaque  
 1010 / **ecolutions®** 1E10 Frosted  
 1011/ BGuard™ Antibacterial

MOQ 500 units.  
 Standard colours combination



No extra charge

BGuard™

**ecolutions®**



Standard colours combination\*

### Plug

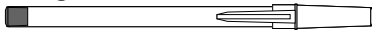

Antibacterial

1BG



### Cap

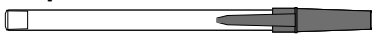

Antibacterial

1BG



### Section

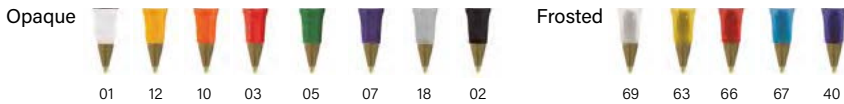
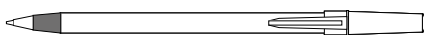

Antibacterial

1BG



### Barrel

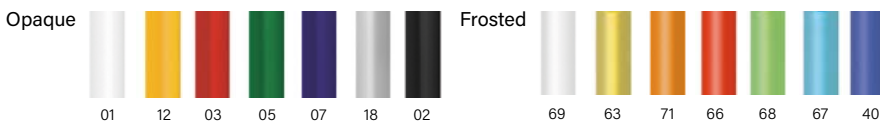

Antibacterial

1BG

Opaque Frosted



Exact colour match: ≥ 10,000 units



\*\*Excluding ink system  
 Add the Möbius loop to your artwork at no additional charge. Please specify it on your order. (Möbius loop imprint defaults to left-hand corner.)

\*Due to the recycled content of the raw materials used to make the product, we cannot guarantee that the colours shown in the catalogue or colours customised to order will always have the same colour and appearance.  
 \*\* The percentage is calculated based on total weight of the product excluding ink system.

Decoration

1010 / 1E10

**BIC® ROUND STIC®**

1010

ecolutions® 1E10

A SP: max. 3 col.

B SP: max. 1 col.

C SP: max. 1 col.

D DG: full-colour

(Only available on white barrel)

MOQ 500 units.

1011

**BIC® ROUND STIC®  
BGUARD™ ANTIBACTERIAL**

1011

A SP: max. 2 col.

D DG: full colour.

(Only available on white barrel)

MOQ 500 units.

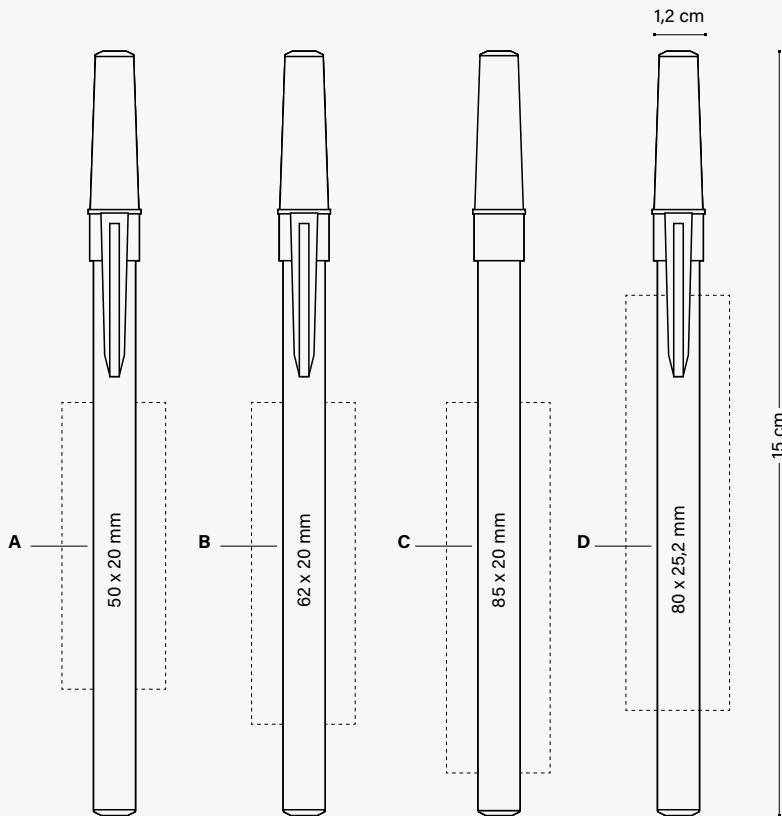

OPTIONAL SPECIAL PACKAGING



PLASTIC POUCH



BIC COLLECTION BOX SLIM PENS

New!

+ INFO PAGES 262 TO 266

EXTERNAL PACKAGING



500 ± 2,5 KG

Can be used as bookmark



PERSONALIZED COLOURS



MANUFACTURED AND PRINTED IN BIC FACTORIES



MADE IN SPAIN



REGULATORY COMPLIANCE



WRITING MODES



BALLPEN M Ø 1 MM

PRINTING TECHNIQUES



SCREEN PRINTING



DIGITAL

SUSTAINABILITY



IMPRIM'VERT®

ecolutions®



FRUIT AND VEGETABLE TRAYS



100% ELECTRICITY COMING FROM RENEWABLE SOURCES

See pages 274-277 for a detailed explanation of the icons

BIC GRAPHIC

BIC® WRITING INSTRUMENTS

OTHER WRITING INSTRUMENTS

NOTEBOOKS

BIC® / DLEEP® LIGHTERS AND BIC® CASES

BIC® PACKAGING

GENERAL INFORMATION



Embossed  
iconic BIC®  
brand!

1590

BIC® M10® CLIC  
1590

Colour ink



01

8G

10

14

59

04

02

3D

100%

●  
Only available  
in black ink

1590

**BIC® M10® CLIC**  
1590

A SP: max. 2 col.

MOQ 500 units

Decoration

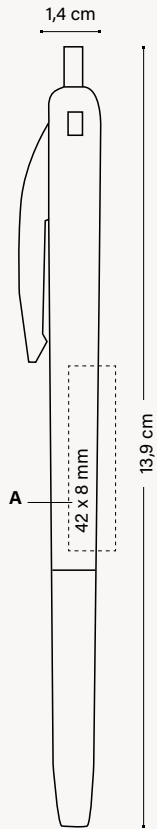

OPTIONAL SPECIAL PACKAGING



PLASTIC  
POUCH



WINDOW  
BOX

+ INFO PAGES 262 TO 266

*Can be used  
as bookmark*

EXTERNAL PACKAGING



500 ± 4,1 KG



MANUFACTURED  
AND PRINTED IN  
BIC FACTORIES



MADE IN FRANCE



WHITE COLOUR  
MANUFACTURED IN SAF



REGULATORY  
COMPLIANCE



WRITING  
MODES



BALLPEN M  
Ø 1 MM

PRINTING  
TECHNIQUES



SCREEN PRINTING

SUSTAINABILITY



IMPRIM'VERT®



100% ELECTRICITY COMING  
FROM RENEWABLE SOURCES



CHECK OUT THE  
VIDEO

See pages 274-277 for a detailed explanation of the icons



# **BIC** Media Clic

One of the best sellers in the industry, a functional and widely recognized design, our BIC® Media Clic is a long lasting product available in different materials. Choose between the Standard, Recycled, Biobased, Antibacterial and premium finishes.

Be inspired with the wide range of finishes and colours, and match them to enhance your brand.

FR

Notre BIC® Media Clic, un best-seller de l'industrie, au design fonctionnel et largement reconnu, est un produit durable disponible dans différents matériaux. Choisissez parmi le Standard, Recyclé, Biobased, Antibactérien et finitions premium.

Laissez-vous inspirer par la vaste gamme de finitions et de couleurs, et associez-les pour mettre en valeur votre marque.

IT

Uno dei bestseller del settore, dal design funzionale e ampiamente riconosciuto, la nostra BIC® Media Clic è un prodotto di lunga durata disponibile in diversi materiali. Scegli tra i modelli Standard, Riciclato, Biobased, Antibatterico e finiture premium.

Lasciati ispirare dall'ampia gamma di finiture e colori e abbinali per valorizzare il tuo marchio.

DE

Einer der Bestseller in der Werbeartikelindustrie, funktional und mit hohem Wiedererkennungswert. Unser BIC® Media Clic ist ein langlebiges Produkt, erhältlich in verschiedensten Materialien. Wählen Sie zwischen Standard-, Recyclen-, Biobasierten-, Antibakteriellen- und Premium-Veredelungen.

Lassen Sie sich von einer Vielzahl an Ausführungen und Farben inspirieren und passen Sie ihn optimal an Ihre Marke an.

ES

Uno de los más vendidos en la industria, con un diseño funcional y ampliamente reconocido, nuestro BIC® Media Clic es un producto duradero disponible en diferentes materiales. Elige entre estándar, reciclado, de material biológico, antibacteriano y acabados premium.

Déjate inspirar por la amplia gama de acabados y colores, y combínalos para realzar tu marca.

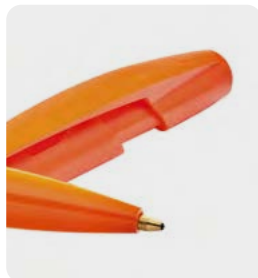

**ECOLUTIONS®**  
**GRIP**  
**GRIP ECOLUTIONS®**  
**BGUARD™ ANTIBACTERIAL**  
**BGUARD™ ANTIMICROBIAL**  
**BIOBASED**  
**BIOBASED BGUARD™ ANTIBACTERIAL**  
**SHINE**  
**GLACÉ**

1025



Embossed  
iconic  
BIC® brand!



Also in  
Mechanical  
pencil

**BIC® MEDIA CLIC**

1025 Ballpen / 1028 Mechanical pencil (see page 174)

Opaque

Colour ink



Red Ink available under request





ECO version and standard at the same price!

**ecolutions®**

MADE FROM **98% RECYCLED MATERIAL\***  
\*From barrel

PLASTIC CAR PARTS

**1E25**

**BIC® MEDIA CLIC**  
1E25 Ballpen  
Opaque  
Colour ink  
● ● ●

**MIX & MATCH**

PERSONALIZED COLOURS

MANUFACTURED AND PRINTED IN BIC FACTORIES

MADE IN SPAIN

REGULATORY COMPLIANCE

ISO certified

WRITING MODES

BALLPEN M Ø 1 MM

PRINTING TECHNIQUES

SP  
SCREEN PRINTING

DG  
DIGITAL

SUSTAINABILITY

IMPRIM'VERT®

ecolutions®

PLASTIC CAR PARTS

100% ELECTRICITY COMING FROM RENEWABLE SOURCES

See pages 274-277 for a detailed explanation of the icons

\*The percentage is calculated based on total weight of the barrel. Due to the recycled content of the raw materials used to make the product, we cannot guarantee that the colours shown in the catalogue or colours customised to order will always have the same colour and appearance.

1025

Also in  
Mechanical  
pencil

**BIC® MEDIA CLIC**

1025 Ballpen / 1028 Mechanical pencil (see page 174)

Frosted

Colour ink



Red Ink available under request



1020 / 1021

**BIC® MEDIA CLIC GRIP**

1020 Ballpen

1021 Mechanical pencil (see page 175)

Frosted

Colour ink



Also in  
Mechanical  
pencil



01/69



71/69



82/69



40/69

100%

MIX &  
MATCH



PERSONALIZED  
COLOURS



MANUFACTURED  
AND PRINTED IN  
BIC FACTORIES



MADE  
IN SPAIN



REGULATORY  
COMPLIANCE



ISO  
certified

WRITING  
MODES



BALLPEN M  
Ø 1 MM

PRINTING  
TECHNIQUES



SCREEN PRINTING



DIGITAL

SUSTAINABILITY



IMPRIM'VEERT®



100% ELECTRICITY COMING  
FROM RENEWABLE SOURCES

See pages 274-277 for a detailed explanation of the icons

MIX & MATCH



PERSONALIZED COLOURS



MANUFACTURED AND PRINTED IN BIC FACTORIES



MADE IN SPAIN



REGULATORY COMPLIANCE



WRITING MODES



BALLPEN M  
Ø 1 MM

PRINTING TECHNIQUES



SCREEN PRINTING



DIGITAL

SUSTAINABILITY



IMPRIM'VERT®

ecolutions®



PLASTIC CAR PARTS



100% ELECTRICITY COMING FROM RENEWABLE SOURCES

Also in Mechanical pencil

ECO version and standard at the same price!

ecolutions®



MADE FROM 98% RECYCLED MATERIAL\*  
\*From barrel



PLASTIC CAR PARTS

1E20 / 1E21

BIC® MEDIA CLIC GRIP

1E20 Ballpen

1E21 Mechanical pencil (see page 175)

Opaque

Colour ink



01/03



01/05



01/02



01/07

100%

# MIX & MATCH No extra charge

MOQ 500 units  
ecolutions® Standard colours combination

## Plug

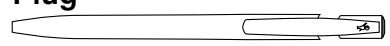

- Opaque 01 12 10 03 5C 2D 13 5G 05 3D 04 07 18 02

- Frosted 69

## Clip

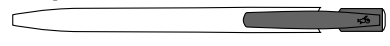

- 01 12 10 03 5C 2D 13 5G 05 3D 04 07 18 02

- Opaque 69

## Barrel



- Opaque 01 12 10 03 5C 2D 13 5G 05 3D 04 07 3C 18 02

- Frosted 69 63 71 66 68 82 67 40 4B

## Barrel & Grip

- 01/69 71/69 82/69 40/69

Exact colour match: ≥ 10.000 units 1025/1E25  
Exact colour match: ≥ 20.000 units 1020/1E20



**ecolutions®**

PLASTIC CAR PARTS

Standard colours combination\*

Opaque 1E 3E

Barrel & Grip Opaque 01/03 01/05 01/07 01/02

98%

\*From barrel

Add the Möbius loop to your artwork at no additional charge. Please specify "Print the Möbius loop" on your order. (Möbius loop imprint defaults to left-hand corner.)



- PERSONALIZED COLOURS
- MANUFACTURED AND PRINTED IN BIC FACTORIES

- PRINTING TECHNIQUES**
- SP SCREEN PRINTING
  - DG DIGITAL

- WRITING MODES**
- BALLPEN M Ø 1 MM

- SUSTAINABILITY**
- PLASTIC CAR PARTS

\*Due to the recycled content of the raw materials used to make the product, we cannot guarantee that the colours shown in the catalogue or colours customised to order will always have the same colour and appearance.

See pages 274-277 for a detailed explanation of the icons

1025 / 1028 / 1E25

**BIC® MEDIA CLIC**

1025 Ballpen  
 1028 Mechanical pencil (see page 174)  
 ecolutions® 1E25 Ballpen

**A SP:** max. 4 col.  
**B SP:** max. 2 col.  
**C DG:** full-colour

MOQ 500 units.

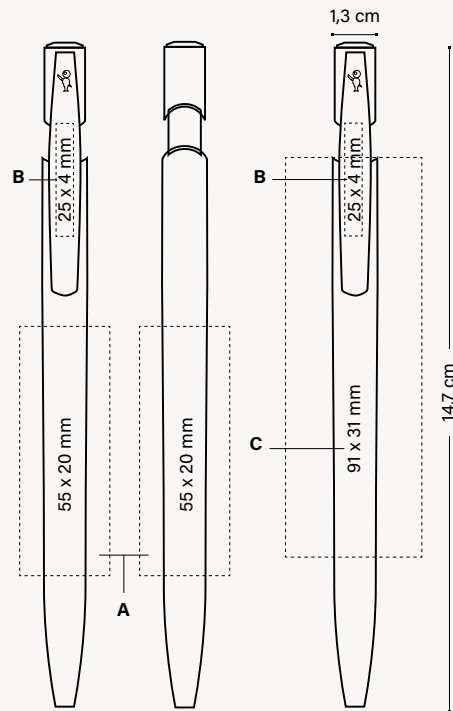

**OPTIONAL SPECIAL PACKAGING**

**EXTERNAL PACKAGING**



ECO SLEEVE



PLASTIC POUCH



WINDOW BOX



500 ± 4,1 KG

+ INFO PAGES 262 TO 266

*Can be used as bookmark*



MANUFACTURED AND PRINTED IN BIC FACTORIES



MADE IN SPAIN

**PRINTING TECHNIQUES**

**SP** SCREEN PRINTING

**DG** DIGITAL

**WRITING MODES**

**BALLPEN M**  
 Ø 1 MM

**SUSTAINABILITY**

**PLASTIC CAR PARTS**

1020 / 1E20 / 1021 / 1E21

**BIC® MEDIA CLIC GRIP**

1020 Ballpen  
1021 Mechanical pencil  
(see page 175)

**D SP:** max. 4 col.

**E SP:** max. 2 col.

**F DG:** full-colour

MOQ 500 units.

**ecolutions® 1E20 Ballpen**

**ecolutions® 1E21 Mechanical pencil**  
(see page 175)

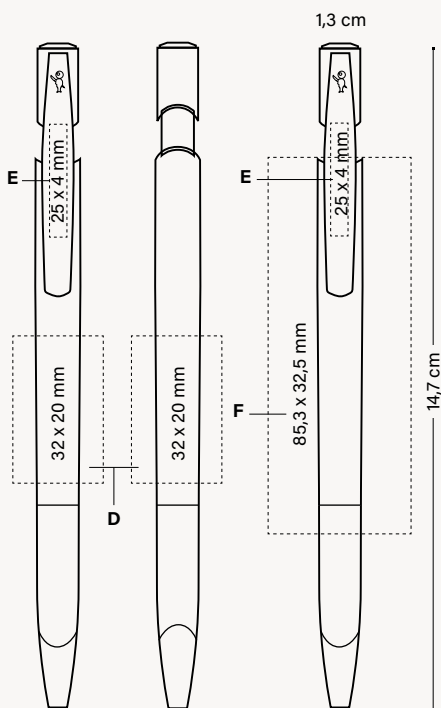

**OPTIONAL SPECIAL PACKAGING**



ECO SLEEVE

+ INFO PAGES 262 TO 266



PLASTIC POUCH

*Can be used as bookmark*



WINDOW BOX



500 ± 4,3 KG

**EXTERNAL PACKAGING**



MANUFACTURED AND PRINTED IN BIC FACTORIES



MADE IN SPAIN

**PRINTING TECHNIQUES**

**SP** SCREEN PRINTING

**DG** DIGITAL

**WRITING MODES**

**BALLPEN M**  
Ø 1 MM

**SUSTAINABILITY**

**PLASTIC CAR PARTS**

1975

## BIC® MEDIA CLIC SHINE

1975 Ballpen

Opaque

Colour ink



*Red Ink available under request*



47



26

100%

# MIX & MATCH No extra charge

MOQ 500 units. Standard colours combination.

## Plug

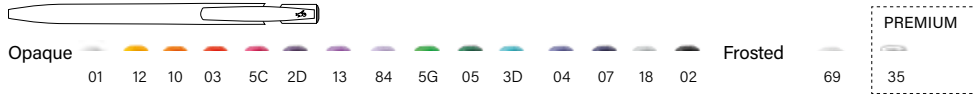

## Clip

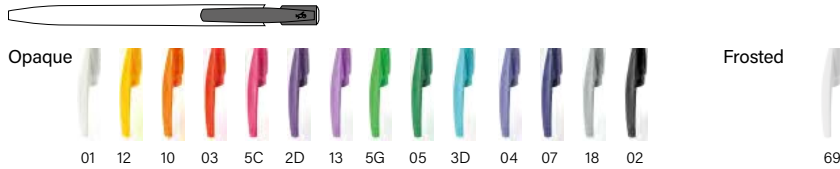

## Barrel

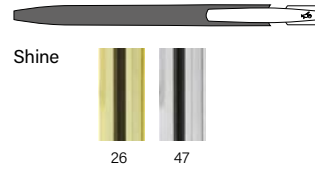

## Decoration

1975

### BIC® MEDIA CLIC SHINE

1975  
**A SP:** max. 2 col.  
**B SP:** max. 2 col.  
 MOQ 500 units.

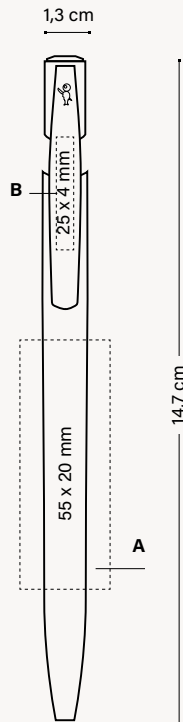

### OPTIONAL SPECIAL PACKAGING



+ INFO PAGES 262 TO 266

*Can be used as bookmark*

### EXTERNAL PACKAGING



### WRITING MODES



### PRINTING TECHNIQUES



### SUSTAINABILITY



100% ELECTRICITY COMING FROM RENEWABLE SOURCES

See pages 274-277 for a detailed explanation of the icons

BIC® MEDIA CLIC GLACÉ

# Our bestseller in elegant colours.

1030

BIC® MEDIA CLIC GLACÉ

1030 Opaque

Colour ink



*Red Ink available under request*



47G



76



03G



05G



04G



14G

FR

Des couleurs  
élégantes pour  
notre best-seller.

DE

Elegante Farben für  
unseren Bestseller.

IT

Il nostro best seller  
in abito elegante.

ES

Colores elegantes  
en nuestro best seller.

# MIX & MATCH No extra charge

MOQ 500 units  
Standard colours combination

## Plug



## Clip

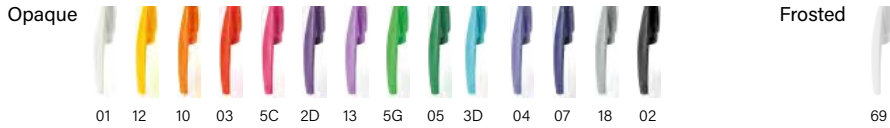

## Barrel

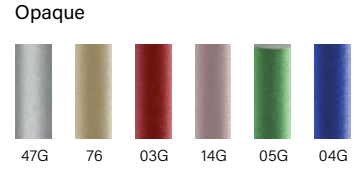

## Decoration

1030

### BIC® MEDIA CLIC GLACÉ

1030

A SP: max. 2 col.

B SP: max. 2 col.

MOQ 500 units.

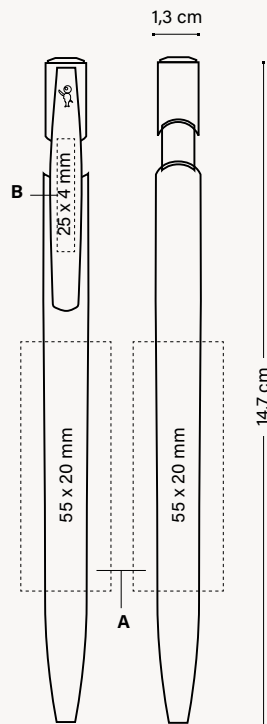

### OPTIONAL SPECIAL PACKAGING



+ INFO PAGES 262 TO 266

*Can be used as bookmark*

### EXTERNAL PACKAGING



### SUSTAINABILITY



See pages 274-277 for a detailed explanation of the icons

---

**BIC® CLIC STIC**

**Modern, flexible,  
reliable. That's how  
BIC® Clic Stic is!**



*Thousands of colour  
combinations!*

FR  
**Moderne, souple, fiable.  
Le BIC® Clic Stic est ainsi!**

DE  
**Modern, flexibel, zuverlässig.  
So ist der BIC® Clic Stic!**

IT  
**Moderna, flessibile, affidabile.  
Ecco com'è BIC® Clic Stic !**

ES  
**Moderno, flexible, fiable.  
¡Así es BIC® Clic Stic!**

1000

**BIC® CLIC STIC**  
1000 Opaque

Colour ink  
● ● ● ● ● ●



*Iconic  
BIC® Boy  
is embossed*

Available on  
white barrel



*ECO version and  
standard at the same price!*

**ecolutions®**  
MADE FROM **87% RECYCLED MATERIAL\***  
\*Excluding ink system

FRUIT AND VEGETABLE TRAYS

1E00

**BIC® CLIC STIC**  
1E00 Opaque

Colour ink  
● ● ● ● ● ●



Available on  
white barrel



**MIX & MATCH**



PERSONALIZED COLOURS



MANUFACTURED AND PRINTED IN BIC FACTORIES



MADE IN SPAIN



REGULATORY COMPLIANCE



ISO certified

WRITING MODES



BALLPEN M 0.1 MM

PRINTING TECHNIQUES



SCREEN PRINTING



DIGITAL

SUSTAINABILITY

IMPRIM'VERT®



FRUIT AND VEGETABLE TRAYS



100% ELECTRICITY COMING FROM RENEWABLE SOURCES

\*The percentage is calculated based on total weight of the pen excluding ink system. Due to the recycled content of the raw materials used to make the product, we cannot guarantee that the colours shown in the catalogue or colours customised to order will always have the same colour and appearance.

ECO version and standard at the same price!

**ecolutions®**

MADE FROM **87% RECYCLED MATERIAL\***  
 \*Excluding ink system

FRUIT AND VEGETABLE TRAYS



1000

**BIC® CLIC STIC**  
1000 Frosted

Colour ink  
● ● ●

Red Ink available under request



69 63 71 66 68 40 67

1E00

**BIC® CLIC STIC**  
1E00 Frosted

Colour ink  
● ● ●

Red Ink available under request



2E/8E 2E/10E 2E/3E 2E/7E

\*The percentage is calculated based on total weight of the pen excluding ink system. Due to the recycled content of the raw materials used to make the product, we cannot guarantee that the colours shown in the catalogue or colours customised to order will always have the same colour and appearance.

1005

**BIC® CLIC STIC  
SOFTFEEL®**  
1005 Opaque

Colour ink  
● ● ●

*Red Ink available  
under request*



20



07



02

100%

1005

**BIC® CLIC STIC  
SOFTFEEL®**  
1005 Frosted

Colour ink  
● ● ●

*Red Ink available under  
request*



40

100%

**MIX &  
MATCH**



PERSONALIZED  
COLOURS



MANUFACTURED  
AND PRINTED IN  
BIC FACTORIES



MADE IN SPAIN



REGULATORY  
COMPLIANCE



WRITING  
MODES



BALLPEN M  
0.1 MM

PRINTING  
TECHNIQUES



SCREEN PRINTING



DIGITAL

SUSTAINABILITY



IMPRIM'VEERT®

eCOlutions®



FRUIT AND  
VEGETABLE TRAYS



100% ELECTRICITY COMING  
FROM RENEWABLE SOURCES

See pages 274-277 for a detailed explanation of the icons

**MIX & MATCH**



PERSONALIZED COLOURS



MANUFACTURED AND PRINTED IN BIC FACTORIES



MADE IN SPAIN



REGULATORY COMPLIANCE



**WRITING MODES**



BALLPEN M 0.1 MM

**PRINTING TECHNIQUES**



SCREEN PRINTING



DIGITAL

**SUSTAINABILITY**



IMPRIM'VERT®



FRUIT AND VEGETABLE TRAYS



100% ELECTRICITY COMING FROM RENEWABLE SOURCES

*ECO version and standard at the same price!*

**ecolutions®**



MADE FROM 87% RECYCLED MATERIAL\*

\*Excluding ink system



FRUIT AND VEGETABLE TRAYS

## 1847

### BIC® CLIC STIC STYLUS

1847 Opaque

Colour ink



Red Ink available under request



01

03

04

02

07

100%

## 1846

### BIC® CLIC STIC STYLUS

1846 Opaque

Colour ink



Red Ink available under request



1E

3E

100%

See pages 274-277 for a detailed explanation of the icons

\*The percentage is calculated based on total weight of the pen excluding ink system. Due to the recycled content of the raw materials used to make the product, we cannot guarantee that the colours shown in the catalogue or colours customised to order will always have the same colour and appearance.

# MIX & MATCH

No extra charge

MOQ 500 units. Standard colours combination

## Plug

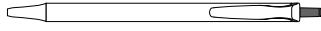

Opaque



Frosted



## Clip

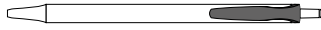

Opaque

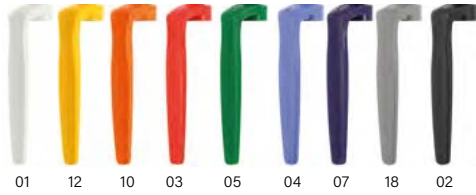

Frosted



## Section

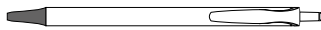

Opaque



Frosted

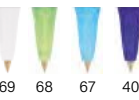

## Stylus

Opaque



## Barrel



Opaque

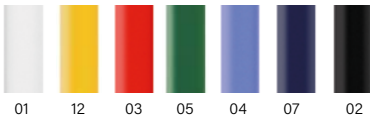

## Stylus

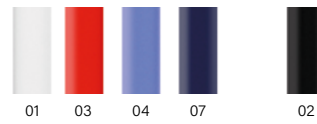

## Softfeel®

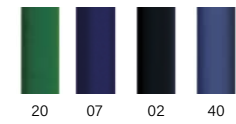

Frosted

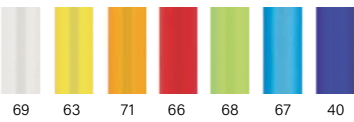

Exact colour match:  $\geq 10.000$  units

**ecolutions®**

MOQ 500 units  
ecolutions® Standard colours combination\*\*



\*Excluding ink system

Add the Möbius loop to your artwork at no additional charge. Please specify it on your order. (Möbius loop imprint defaults to left-hand corner.)

FRUIT AND VEGETABLE TRAYS



## Plug



Opaque



## Section

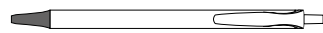

Opaque



## Stylus

Opaque



## Clip



Opaque



## Barrel



Opaque



Frosted



## Stylus

Opaque



Exact colour match:  $\geq 10.000$  units

\*\*Due to the recycled content of the raw materials used to make the product, we cannot guarantee that the colours shown in the catalogue or colours customised to order will always have the same colour and appearance.



PERSONALIZED COLOURS



MANUFACTURED AND PRINTED IN BIC FACTORIES



MADE IN SPAIN



REGULATORY COMPLIANCE



WRITING MODES



BALLPEN M 0.1 MM

PRINTING TECHNIQUES



SCREEN PRINTING



DIGITAL

SUSTAINABILITY



IMPRIM'VERT®



FRUIT AND VEGETABLE TRAYS



100% ELECTRICITY COMING FROM RENEWABLE SOURCES

1000 / 1E00 / 1847 / 1846

**BIC® CLIC STIC**

1000 / **ecolutions®** 1E00

**BIC® CLIC STIC STYLUS**

1847 / **ecolutions®** 1846

**A SP:** max. 3 col.

**B SP:** max. 1 col.

**C SP:** max. 2 col.

**D DG:** full-colour (area for text)

(Only available on white barrel)

MOQ 500 units.

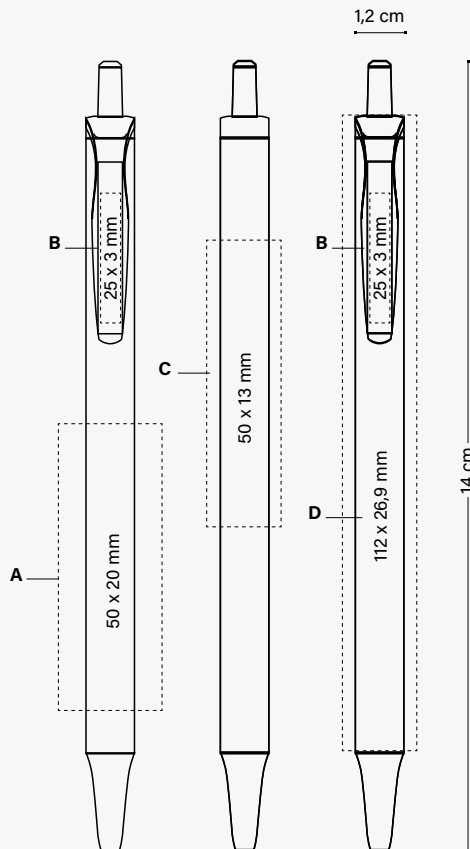

**OPTIONAL SPECIAL PACKAGING**



ECO SLEEVE



PLASTIC POUCH

+ INFO PAGES 262 TO 266

Can be used as bookmark

**EXTERNAL PACKAGING**



500 ± 2,9 KG

1005

**BIC® CLIC STIC SOFTFEEL®**  
1005

A/B SP: max. 1 col.

MOQ 500 units.

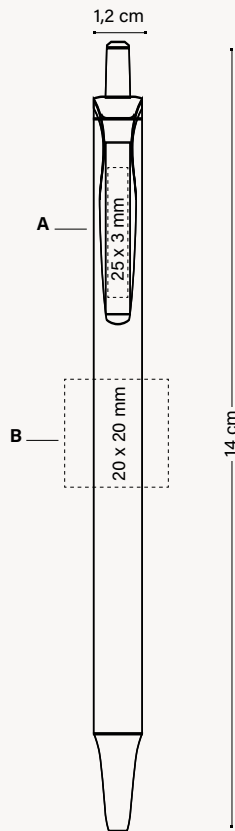

## Decoration

**MIX & MATCH**



PERSONALIZED COLOURS



MANUFACTURED AND PRINTED IN BIC FACTORIES



MADE IN SPAIN



REGULATORY COMPLIANCE



ISO certified

WRITING MODES



BALLPEN M  
Ø 1 MM

PRINTING TECHNIQUES



SCREEN PRINTING



DIGITAL

SUSTAINABILITY



IMPRIM'VERT®



100% ELECTRICITY COMING FROM RENEWABLE SOURCES

### OPTIONAL SPECIAL PACKAGING



ECO SLEEVE



PLASTIC POUCH



BIC COLLECTION BOX SLIM PENS

*New!*

+ INFO PAGES 262 TO 266

*Can be used as bookmark*

### EXTERNAL PACKAGING



500 ± 2,9 KG

See pages 274-277 for a detailed explanation of the icons

BIC GRAPHIC

BIC® WRITING INSTRUMENTS

OTHER WRITING INSTRUMENTS

NOTEBOOKS

BIC® / D/EEP® LIGHTERS AND BIC® CASES

BIC® PACKAGING

GENERAL INFORMATION



Discover the eye-catching clip and its gentle twist mechanism. Large printing areas offer a wide range of personalisation possibilities in the standard and advance versions. Now also available in soft and glacé versions.

In addition, the BIC® Super Clip Origin, a more innovative and sustainable pen.

Welcome to the future!

FR

Découvrez le clip attrayant et son mécanisme pivotant silencieux. La grande zone d'impression XXL offre une vaste gamme de possibilités de personnalisation dans la version Standard et Advance. Également dans les versions Soft et Glacé.

De plus, le BIC® Super Clip Origin est le premier stylo d'une nouvelle étape plus innovatrice et durable.

Bienvenus dans le futur !

IT

Scopri l'accattivante clip e il suo fluido meccanismo twist. La grande area di stampa XXL offre un'ampia gamma di possibilità di personalizzazione nelle versioni standard e advance. Ora disponibile anche nelle versioni soft e glacé.

Inoltre, la BIC® Super Clip Origin è la prima penna a sfera di una nuova fase più innovativa e sostenibile.

Benvenuti nel futuro!

DE

Entdecken Sie den auffälligen Clip und seinen sanften Drehmechanismus. Der XXL-Druckbereich bietet vielseitige Personalisierungsmöglichkeiten bei der Standard und Advance-Version. Jetzt auch in Soft- und Glacé-Version.

Außerdem ist der BIC® Super Clip Origin der erste Kugelschreiber einer neuen innovativeren und nachhaltigeren Etappe.

Willkommen in der Zukunft!

ES

Descubre el llamativo clip y su mecanismo giratorio suave. La gran área de marcaje XXL ofrece una amplia variedad de posibilidades de personalización en la versión estándar y advance. Ahora también en las versiones soft y glacé.

Además, el BIC® Super Clip Origin es el primer bolígrafo de una nueva etapa más innovadora y sostenible.

¡Bienvenidos al futuro!



**ECOLUTIONS®**  
**ADVANCE**  
**GLACÉ**  
**GLACÉ ADVANCE**  
**SOFT**  
**SOFT ADVANCE**  
**ORIGIN**



1039

**BIC® SUPER CLIP**  
1039 Opaque

Colour ink  
● ●



Large  
printing  
areas!



Available on  
white barrel



ECO version and standard at the same price!

**ecolutions®**

**MADE FROM 90% RECYCLED MATERIAL\***  
\*Excluding ink system

90%

PLASTIC CAR PARTS

1E50

**BIC® SUPER CLIP**  
1E50 Opaque

Colour ink  
● ●



1E

1039

**BIC® SUPER CLIP**  
1039 Clear

Colour ink  
● ●



51

87

86

89

88

**MIX & MATCH**



PERSONALIZED COLOURS



MANUFACTURED AND PRINTED IN BIC FACTORIES



MADE IN SPAIN



REGULATORY COMPLIANCE



WRITING MODES



BALLPEN M  
Ø 1 MM

PRINTING TECHNIQUES



SCREEN PRINTING



DIGITAL



BRITEPIX™  
BRITEPIX™ TEXTURE  
BRITEPIX™ PERSONALISATION

SUSTAINABILITY



IMPRIM'VEERT®

ecolutions®



PLASTIC CAR PARTS



100% ELECTRICITY COMING FROM RENEWABLE SOURCES

BIC GRAPHIC

BIC® WRITING INSTRUMENTS

OTHER WRITING INSTRUMENTS

NOTEBOOKS

BIC® / DLEEP® LIGHTERS AND BIC® CASES

BIC® PACKAGING

GENERAL INFORMATION

See pages 274-277 for a detailed explanation of the icons

\*The percentage is calculated based on total weight of the pen excluding ink system. Due to the recycled content of the raw materials used to make the product, we cannot guarantee that the colours shown in the catalogue or colours customised to order will always have the same colour and appearance.

# BIC® SUPER CLIP

1039 / 1E50

## BIC® SUPER CLIP

1039 Opaque

ecolutions® 1E50 Opaque

1039 Clear

MOQ 250 units

Standard colours combination

**MIX & MATCH**

No extra charge

### Clip



Opaque



Clear

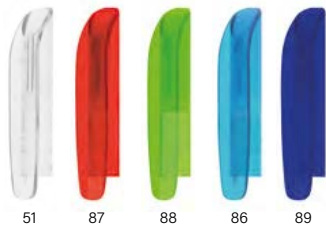

ecolutions®



Standard colours combination\*



\*Excluding ink system

Add the Möbius loop to your artwork at no additional charge. Please specify it on your order. (Möbius loop imprint defaults to left-hand hand corner.)

### Barrel



Opaque

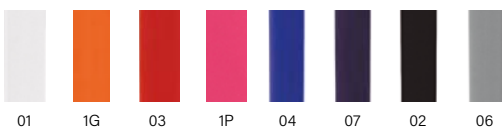

Clear

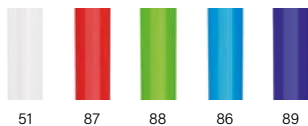

Exact colour match:  $\geq 10.000$  units



\*Due to the recycled content of the raw materials used to make the product, we cannot guarantee that the colours shown in the catalogue or colours customised to order will always have the same colour and appearance.

Decoration

1039 / 1E50

**BIC® SUPER CLIP**

1039

**ecolutions®** 1E50

**A SP:** max. 2 col.

**B SP:** max. 1 col.

**C DG:** full-colour

**D BP:** full-colour

**BP Texture:** full-colour

MOQ 250 units.

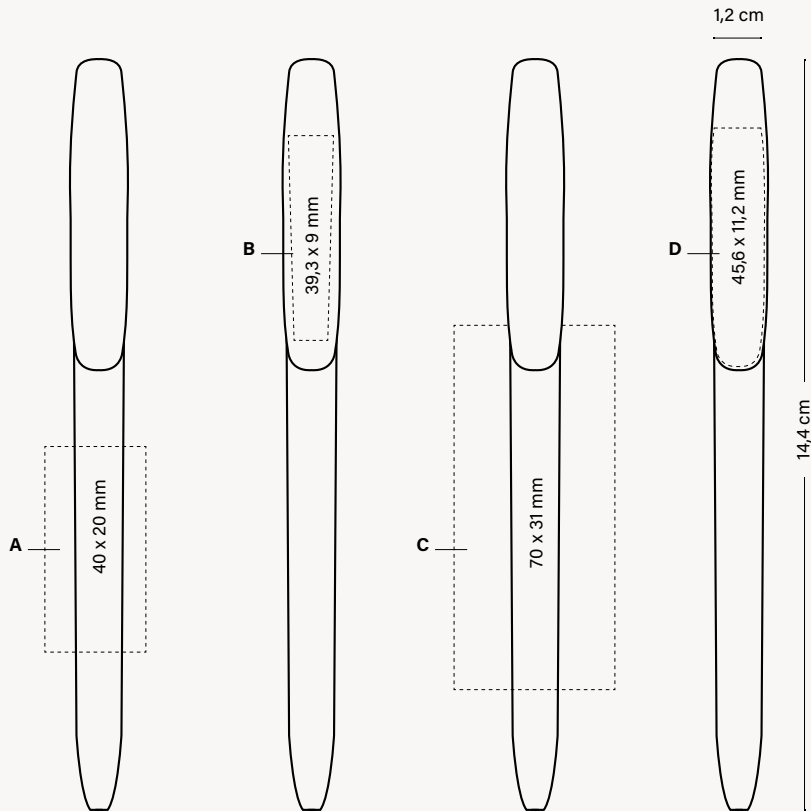

**OPTIONAL SPECIAL PACKAGING**



+ INFO PAGES 262 TO 266

*Can be used as bookmark*

*Collection Box (1, 2 & 3 units)*

**EXTERNAL PACKAGING**



250 ± 2,6 KG



**WRITING MODES**



**PRINTING TECHNIQUES**

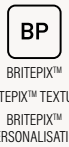

**SUSTAINABILITY**



See pages 274-277 for a detailed explanation of the icons

BIC GRAPHIC

BIC® WRITING INSTRUMENTS

OTHER WRITING INSTRUMENTS

NOTEBOOKS

BIC® / D'LEEP® LIGHTERS AND BIC® CASES

BIC® PACKAGING

GENERAL INFORMATION

1073

**BIC® SUPER CLIP ADVANCE**

1073 Opaque

Colour ink





06/35



02/35



1P/35



01/35



Gentle twist mechanism!



Large printing areas!



360° Printing



Refill service on request

100%

Available on white barrel



MIX & MATCH



PERSONALIZED COLOURS



MANUFACTURED AND PRINTED IN BIC FACTORIES



MADE IN SPAIN



REGULATORY COMPLIANCE



WRITING MODES



BALLPEN M 0.1 MM

PRINTING TECHNIQUES



SCREEN PRINTING



DIGITAL



BRITEPIX™  
BRITEPIX™ TEXTURE  
BRITEPIX™ PERSONALISATION

SUSTAINABILITY



IMPRIM'VEERT®



100% ELECTRICITY COMING FROM RENEWABLE SOURCES

See pages 274-277 for a detailed explanation of the icons

# BIC® SUPER CLIP ADVANCE

1073

**BIC® SUPER CLIP ADVANCE**  
1073 Opaque

MOQ 250 units  
Standard colours combination

**MIX & MATCH** No extra charge

## Clip

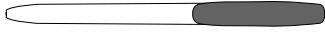

Opaque



## Barrel



Opaque

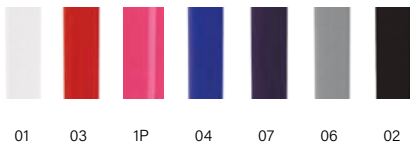

## Section



ADVANCE



35

Exact colour match:  $\geq 10.000$  units



1073

**BIC® SUPER CLIP ADVANCE**

1073

**A SP:** max. 2 col.

**B SP:** max. 1 col.

**C DG:** full-colour

**D BP:** full-colour

**BP Texture:** full-colour

MOQ 250 units.

**Decoration**

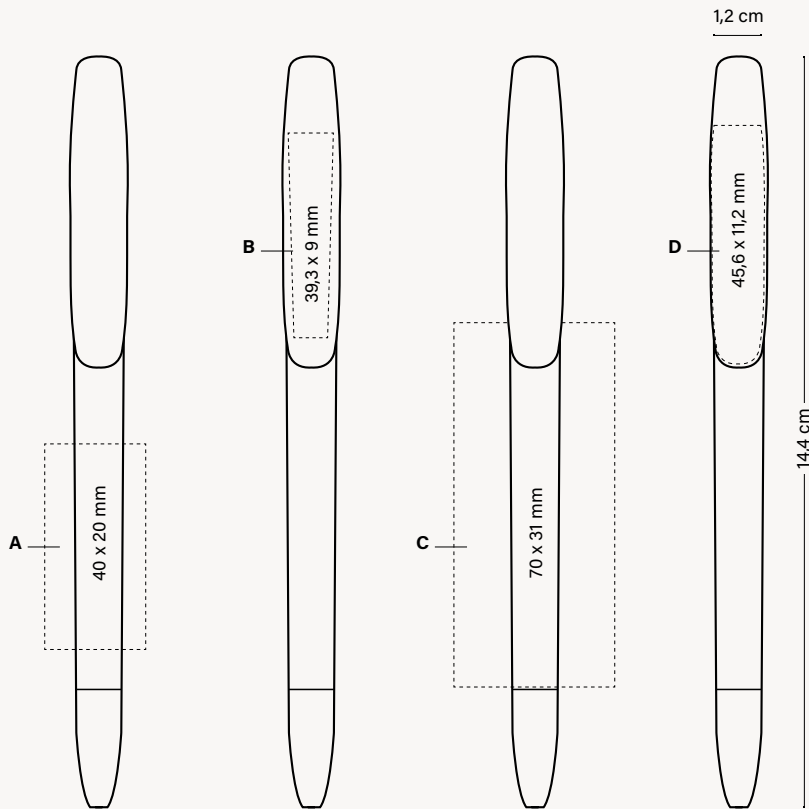

**OPTIONAL SPECIAL PACKAGING**



ECO SLEEVE

+ INFO PAGES 262 TO 266



PLASTIC POUCH

*Can be used as bookmark*



WINDOW BOX



COLLECTION BOX

*Collection Box (1, 2 & 3 units)*

**EXTERNAL PACKAGING**



250 ± 2,6 KG



PERSONALIZED COLOURS



MANUFACTURED AND PRINTED IN BIC FACTORIES



MADE IN SPAIN



REGULATORY COMPLIANCE



ISO certified

**WRITING MODES**



BALLPEN M Ø 1 MM

**PRINTING TECHNIQUES**



SCREEN PRINTING



DIGITAL



BRITEPIX™  
BRITEPIX™ TEXTURE  
BRITEPIX™ PERSONALISATION

**SUSTAINABILITY**



IMPRIM'VERT®



100% ELECTRICITY COMING FROM RENEWABLE SOURCES

BIC® SUPER CLIP GLACÉ

# Discover the BIC® Super Clip in a glamorous version.

1082

BIC® SUPER CLIP GLACÉ  
1082

Colour ink  
● ●



1084

BIC® SUPER CLIP GLACÉ ADVANCE  
1084

Colour ink  
● ●



FR  
Découvrez le  
BIC® Super Clip  
dans sa version  
glamour.

DE  
Entdecken Sie den  
BIC® Super Clip in  
der glamourösen  
Version.

IT  
Scopri la  
BIC® Super Clip  
nella sua versione  
più glamour.

ES  
Descubre el  
BIC® Super Clip  
en su versión  
más glamurosa.

## Section

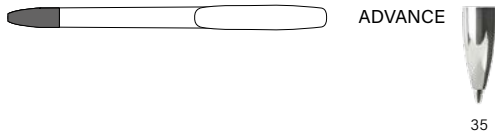

1082 / 1084

**BIC® SUPER CLIP GLACÉ**  
1082

**BIC® SUPER CLIP GLACÉ**  
**ADVANCE**  
1084

**A SP:** max. 1 col.  
**B SP:** max. 1 col.

MOQ 250 units  
Standard colours combination

## Decoration

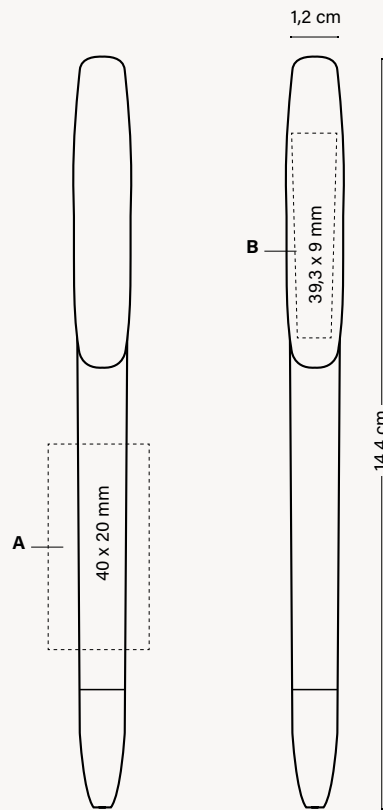

### OPTIONAL SPECIAL PACKAGING



+ INFO PAGES 262 TO 266

*Can be used  
as bookmark*

*Collection Box  
(1, 2 & 3 units)*

### EXTERNAL PACKAGING



250 ± 2,6 KG



PERSONALIZED  
COLOURS



MANUFACTURED  
AND PRINTED IN  
BIC FACTORIES



MADE  
IN SPAIN



REGULATORY  
COMPLIANCE



ISO  
certified

WRITING  
MODES



BALLPEN M  
Ø 1 MM

PRINTING  
TECHNIQUES



SP  
SCREEN PRINTING

SUSTAINABILITY



IMPRIM'VEERT®



100% ELECTRICITY COMING  
FROM RENEWABLE SOURCES



CHECK OUT THE VIDEO

See pages 274-277 for a detailed explanation of the icons

BIC  
GRAPHIC

BIC®  
WRITING INSTRUMENTS

OTHER WRITING  
INSTRUMENTS

NOTEBOOKS

BIC® / DLEEP® LIGHTERS  
AND BIC® CASES

BIC®  
PACKAGING

GENERAL  
INFORMATION

## BIC® SUPER CLIP SOFT & ADVANCE

# Feel the incredible softness of our BIC® Super Clip version with twist mechanism.



1083

**BIC® SUPER CLIP SOFT**  
1083

Colour ink  
● ●



02F

03F

07F

100%

1085

**BIC® SUPER CLIP SOFT  
ADVANCE**  
1085

Colour ink  
● ●



02F/35

03F/35

07F/35

100%



Refill  
service on  
request

FR  
Découvrez  
l'incroyable toucher  
soyeux de notre  
BIC® Super Clip  
avec mécanisme de  
rotation.

DE  
Sie werden den  
unglaublichen  
Seidentouch unseres  
BIC® Super Clip mit  
Drehmechanismus zu  
schätzen wissen.

IT  
Apprezza l'incredibile  
sensazione di setosità  
della BIC® Super Clip.

ES  
Aprecia el  
increíble tacto de  
seda de nuestro  
BIC® Super Clip  
con mecanismo  
giratorio.

## Section

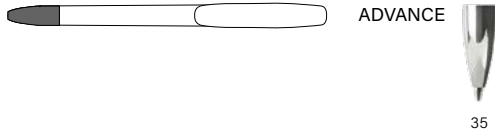

1083 / 1085

**BIC® SUPER CLIP SOFT**  
1083

**BIC® SUPER CLIP SOFT**  
**ADVANCE**  
1085

A SP: max. 1 col.

MOQ 250 units  
Standard colours combination

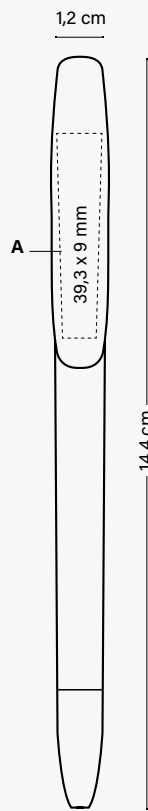

## Decoration



WRITING  
MODES



PRINTING  
TECHNIQUES



SUSTAINABILITY



### OPTIONAL SPECIAL PACKAGING



+ INFO PAGES 262 TO 266



*Can be used  
as bookmark*



*Collection Box  
(1, 2 & 3 units)*

### EXTERNAL PACKAGING



250 ± 2,6 KG



CHECK OUT THE VIDEO

See pages 274-277 for a detailed explanation of the icons

---

BIC® SUPER CLIP ORIGIN

# BIC® Super Clip Origin is made from natural ingredients\*.

## ORIGIN BIOBASED

---

FR

Le BIC® Super Clip Origin est fabriqué à partir de matériaux biosourcés composés de polymères naturels, à l'exclusion d'éléments provenant du pétrole et de combustibles fossiles\*.

Fabriqué avec de l'huile de ricin et d'autres ingrédients d'origine végétale.\*

Fabriqué et imprimé dans des usines alimentées avec **100% d'électricité d'énergie renouvelable**.

**Corps et clip 100 % biosourcés.**

IT

BIC® Super Clip Origin è realizzata in materiale biobased prodotto con ingredienti naturali, nessuno dei quali deriva da petrolio o combustibili fossili\*.

Realizzata con olio di ricino e altri ingredienti di origine vegetale.\*

Prodotto e stampato in stabilimenti alimentati al **100% da energia elettrica rinnovabile**.

**Il fusto e la clip sono al 100% di origine biologica.**

DE

BIC® Super Clip Origin besteht aus biobasiertem Material, das mit natürlichen Polymeren und ohne Erdöl oder fossile Brennstoffe hergestellt wird\*.

Hergestellt mit **Rilsanöl** und anderen Materialien pflanzlichen Ursprungs.\*

Hergestellt und bedruckt in Fabriken, die zu **100 % mit Strom aus erneuerbaren Quellen** betrieben werden.

**Schaft und Clip sind zu 100 % biologischen Ursprungs.**

ES

BIC® Super Clip Origin está hecho de material biológico fabricado con polímeros naturales que excluyen cualquier fuente de petróleo o combustibles fósiles\*.

Elaborado con aceite Rilsan y otros ingredientes de origen vegetal.\*

Fabricado e impreso en fábricas alimentadas con **electricidad 100% renovable**.

**El cuerpo y el clip son 100 % de origen de material biológico.**

\* Refers to barrel and clip.

**BIC® Super Clip Origin is made from biobased material manufactured with natural polymers excluding any source of petroleum or fossil fuels\*.**



Made with castor oil and other ingredients of vegetal origin.\*



Manufactured and printed in factories 100% powered by **electricity produced using renewable sources.**



**Barrel and clip are 100% biosourced.**

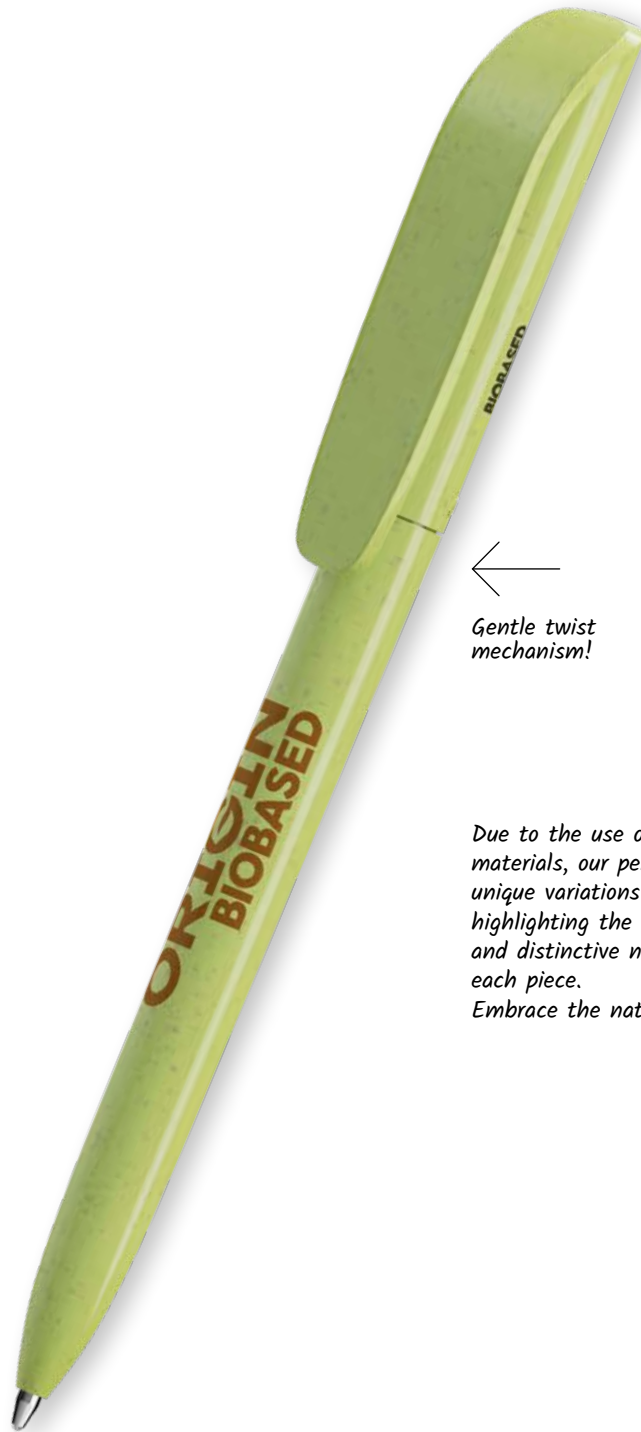

*Gentle twist mechanism!*

*Due to the use of natural materials, our pens feature unique variations in color, highlighting the authentic and distinctive nature of each piece. Embrace the natural charm!*

6CO

\* Refers to barrel and clip.

1038

## BIC® SUPER CLIP ORIGIN

1038 Opaque

Colour ink



60

70

600

1038

**BIC® SUPER CLIP ORIGIN**

1038

A SP: max. 1 col.

MOQ 250 units  
Standard colours combination

**Decoration**

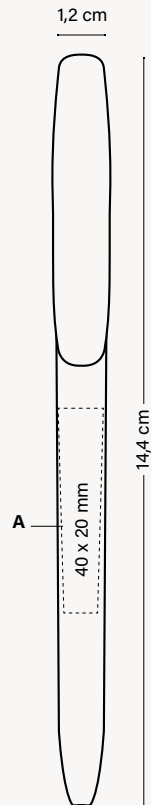

PERSONALIZED COLOURS



MANUFACTURED AND PRINTED IN BIC FACTORIES



MADE IN SPAIN



REGULATORY COMPLIANCE



ISO certified

PRINTING TECHNIQUES



SCREEN PRINTING

SUSTAINABILITY



IMPRIM'VERT®

**ORIGIN BIOBASED**



100% ELECTRICITY COMING FROM RENEWABLE SOURCES

**OPTIONAL SPECIAL PACKAGING**



ECO SLEEVE



PLASTIC POUCH



WINDOW BOX



COLLECTION BOX

+ INFO PAGES 262 TO 266

*Can be used as bookmark*

*Collection Box (1, 2 & 3 units)*

**EXTERNAL PACKAGING**



250 ± 2,6 KG



CHECK OUT THE VIDEO

See pages 274-277 for a detailed explanation of the icons

---

BIC® WIDE BODY™

# The right size to show the true value of your brand!

Wide profile and wide variety of possibilities to maximise your message.



FR

**La taille idéale pour mettre en valeur votre marque !**

Corps large et multiples possibilités pour optimiser votre communication.

IT

**La giusta misura per mostrare il vero valore del tuo marchio!**

Ampio profilo e vasta gamma di possibilità per ottimizzare il tuo messaggio.

DE

**Die richtige Größe, um den Wert Ihrer Marke widerzuspiegeln!**

Breites Profil und eine Vielzahl von Möglichkeiten, Ihre Botschaft klar zu vermitteln.

ES

**¡El tamaño ideal para enseñar el valor real de tu marca!**

De perfil ancho y gran variedad de posibilidades para maximizar tu mensaje.

07



### 1080

**BIC® WIDE BODY™**  
1080 Opaque

Colour ink  
● ● ●

Red Ink available under request



Available on white barrel



### 1E80

**BIC® WIDE BODY™**  
**ecolutions®** 1E80 Opaque

Colour ink  
● ● ●

Red Ink available under request



Available on white barrel



ECO version and standard at the same price!

**ecolutions®**

MADE FROM 98% RECYCLED MATERIAL\*  
\*From barrel

98%

FRUIT AND VEGETABLE TRAYS



WRITING MODES



PRINTING TECHNIQUES



SUSTAINABILITY



See pages 274-277 for a detailed explanation of the icons

\*The percentage is calculated based on total weight of the barrel. Due to the recycled content of the raw materials used to make the product, we cannot guarantee that the colours shown in the catalogue or colours customised to order will always have the same colour and appearance.

**1080**

**BIC® WIDE BODY™**  
1080 Frosted

Colour ink  
● ● ●



40      63      67      68      69      66      71

**1893**

**BIC® WIDE BODY™**  
**MINI DIGITAL**  
1893 Opaque

Colour ink  
● ● ●

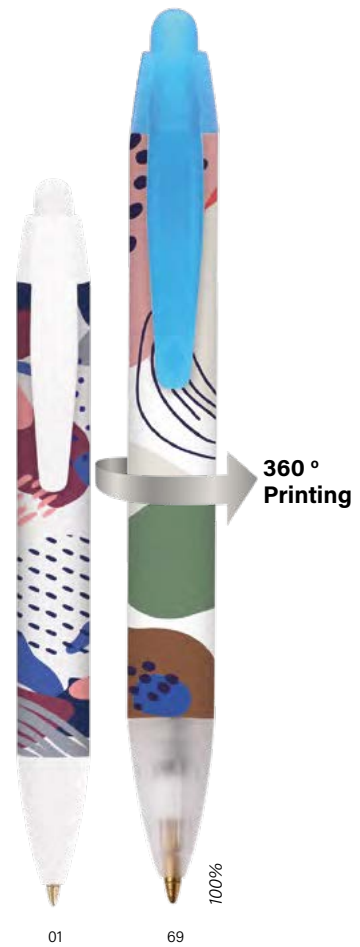

01      69

Available on  
white barrel



1080 / 1E80 / 1893

MOQ 250 units  
Standard colours combination

**MIX & MATCH** No extra charge

### Plug



Opaque



Frosted



### Clip



Opaque



Frosted

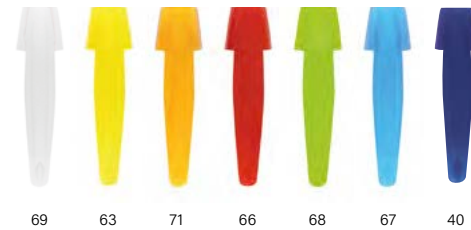

### Barrel



Opaque



Frosted

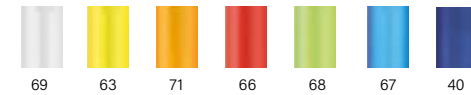

Opaque



**ecolutions®**\*



Add the Möbius loop to your artwork at no additional charge. Please specify "Print the Möbius loop" on your order. (Möbius loop imprint defaults to left-hand corner.)

\*From barrel



FRUIT AND VEGETABLE TRAYS

### Section

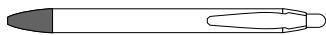

Opaque

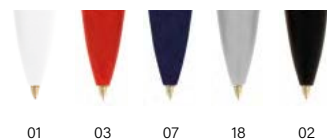

Frosted

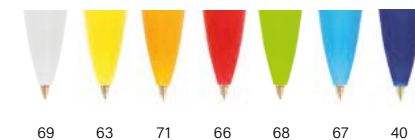

Exact colour match:  $\geq 10.000$  units



**MIX & MATCH**



PERSONALIZED COLOURS



MANUFACTURED AND PRINTED IN BIC FACTORIES



MADE IN SPAIN



REGULATORY COMPLIANCE



ISO certified

WRITING MODES



BALLPEN M 0.1 MM

PRINTING TECHNIQUES



SCREEN PRINTING



DIGITAL

SUSTAINABILITY



IMPRIM'VERT®

ecolutions®



FRUIT AND VEGETABLE TRAYS



100% ELECTRICITY COMING FROM RENEWABLE SOURCES

BIC GRAPHIC

BIC® WRITING INSTRUMENTS

OTHER WRITING INSTRUMENTS

NOTEBOOKS

BIC® / DLEEP® LIGHTERS AND BIC® CASES

BIC® PACKAGING

GENERAL INFORMATION

See pages 274-277 for a detailed explanation of the icons

\*Due to the recycled content of the raw materials used to make the product, we cannot guarantee that the colours shown in the catalogue or colours customised to order will always have the same colour and appearance.

**1080 / 1E80**

**BIC® WIDE BODY™**

1080 Opaque

**ecolutions® 1E80**

A/C SP: max. 2 col.

B/F SP: max. 1 col.

D DG: full-colour (area for images)

E DG: full-colour (area for text)

MOQ 250 units (SP)

MOQ 500 units (DG)

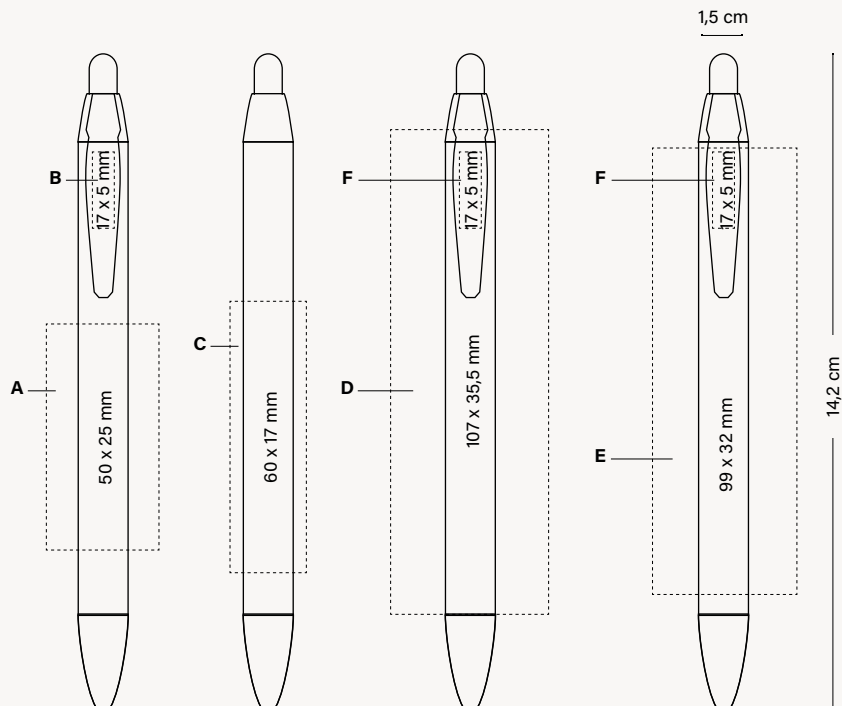

**OPTIONAL SPECIAL PACKAGING**



ECO SLEEVE



PLASTIC POUCH



WINDOW BOX



COLLECTION BOX

+ INFO PAGES 262 TO 266

*Can be used as bookmark*

*Collection Box (1, 2 & 3 units)*

**EXTERNAL PACKAGING**



250 ± 2,6KG

1893

**BIC® WIDE BODY™  
MINI DIGITAL**

1893

**A DG:** full-colour (area for images)  
**B DG:** full-colour (area for text)

MOQ 500 units (DG)

**Decoration**

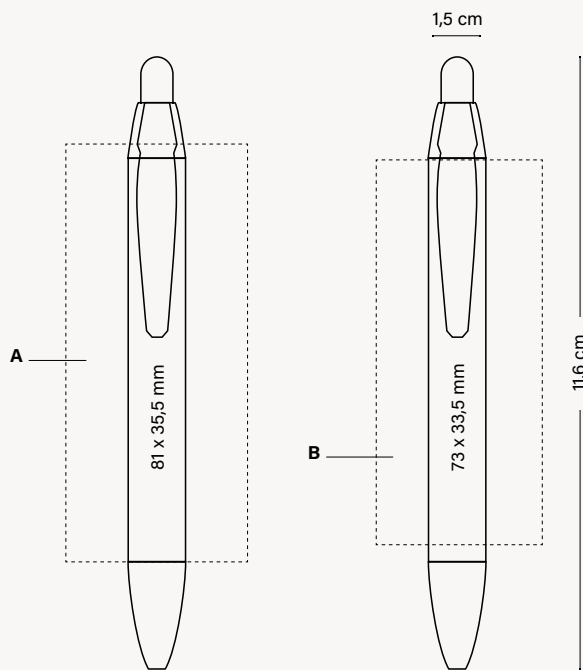

**OPTIONAL SPECIAL PACKAGING**



+ INFO PAGES 262 TO 266

*Can be used  
as bookmark*

**EXTERNAL PACKAGING**



*Collection Box  
(1, 2 & 3 units)*



PERSONALIZED  
COLOURS



MANUFACTURED  
AND PRINTED IN  
BIC FACTORIES



MADE IN SPAIN



REGULATORY  
COMPLIANCE



WRITING  
MODES



BALLPEN M  
Ø 1 MM

PRINTING  
TECHNIQUES



SCREEN PRINTING



DIGITAL

SUSTAINABILITY



IMPRIM'VERT®

ecolutions®



FRUIT AND  
VEGETABLE TRAYS



100% ELECTRICITY COMING  
FROM RENEWABLE SOURCES

# BIC® 4 COLOURS®

The world-renowned BIC® 4 Colours® ballpen gives you the convenience of four different ink colours in one ballpoint pen. For added convenience, it has a lanyard hole, so you can take it with you anywhere.

Discover all the versions: Classic, Fashion, Sun, Fine, Shine, Fluo, 3+1<sup>HB</sup> (with mechanical pencil), Glacé, Soft, Wood Style and the latest versions Rainbow Decor, Pastel, Bicolor, Gradient and Flags Collection.

Don't wait...start your collection today!

FR

Le stylo à bille de renommée mondiale le BIC® 4 Couleurs® vous offre la commodité de quatre couleurs d'encre différentes dans un seul stylo à bille. Pour plus de confort, il est doté d'un anneau pour passer un cordon, vous pouvez donc l'emporter partout avec vous.

Découvrez toutes les différentes versions: Classic, Fashion, Sun, Fine, Shine, Fluo, 3+1<sup>HB</sup> (avec porte-mine), Glacé, Soft, Wood Style et les dernières versions Rainbow Decor, Pastel, Bicolor, Gradient et Flags Collection.

Qu'attendez-vous pour commencer votre Collection ?

IT

BIC® 4 Colours® ti offre la comodità di quattro diversi colori di inchiostro in un'unica penna. Per una maggiore comodità, è dotata di un foro per un laccetto, così da portarla con te ovunque.

Scopri tutte le diverse versioni: Classic, Fashion, Sun, Fine, Shine, Fluo, Stylus, 3+1<sup>HB</sup> (con portamine) Glacé, Soft, Wood Style e le ultimi versioni Rainbow Decor, Pastel, Bicolor, Gradient e Flags Collection.

Cosa aspetti a iniziare la tua collezione?

DE

Der weltbekannte BIC® 4 Colours® Kugelschreiber bietet Ihnen die Verwendung von vier verschiedenen Tintenfarben in einem Stift. Damit ist er eine ausgezeichnete Wahl für das Organisieren von Notizen oder Notieren von Daten in verschiedenen Farben. Dieser vielseitige Kugelschreiber hat eine Strichstärke von 1,0 mm und ist mit langlebiger Tinte ausgestattet. Für zusätzlichen Komfort können Sie ein Trage- oder Schlüsselband befestigen und ihn immer dabei haben.

Entdecken Sie alle Versionen: Classic, Sun, Fashion, Fine, Shine, Fluo, 3+1<sup>HB</sup> (mit Druckbleistift), Glacé, Soft, Wood Style und die neuesten Versionen Rainbow Decor, Pastel, Bicolor, Gradient und Flags Collection.

Worauf warten Sie noch, um mit Ihrer Sammlung zu beginnen?

ES

El mundialmente reconocido bolígrafo BIC® 4 Colours® te ofrece la comodidad de cuatro colores de tinta diferentes en el mismo bolígrafo. Para una mayor comodidad, puedes colgarle un cordón, y llevarlo a cualquier parte.

Descubre todas las versiones: Classic, Sun, Fashion, Fine, Shine, Fluo, 3+1<sup>HB</sup> (con portaminas), Glacé, Soft, Wood Style y las últimas versiones Rainbow Decor, Pastel, Bicolor, Gradient y Flags Collection.

¿A qué esperas para empezar tu colección?



**RAINBOW DECOR**  
**BICOLOR**  
**GRADIENT**  
**PASTEL**  
**FASHION**  
**SUN**  
**FINE**  
**FLUO**  
**GLACÉ**  
**SHINE**  
**SOFT**  
**WOOD STYLE**  
**FLAGS COLLECTION**  
**3+1<sup>HB</sup>**

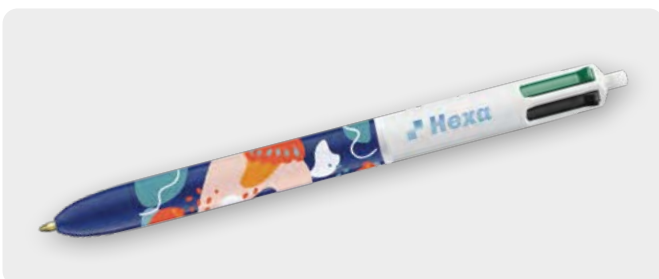

**BIC® 4 COLOURS®**

**Always an icon.**



THE SOLUTION  
FOR FULL COLOUR  
COMMUNICATION!

Now in  
coloured barrels

1100 / 1101

**BIC® 4 COLOURS®**

1100 Opaque  
1101 With lanyard

Colour ink  
● ● ● ●



01/01

02/02

01/03

01/05

01/02

01/12

01/07

FR  
Toujours une icône.

DE  
Immer ein Kultmodell.

IT  
Sempre un'icona.

ES  
Siempre un icono.

1100 / 1101

**BIC® 4 COLOURS®**  
1100/1101

- A SP:** max. 4 col.
- B DG:** Digital print (area for images)
- C BP:** full-colour
- D SP:** 1 col. (only for white upper parts)
- MOQ 250 units (SP, DG)
- MOQ 100 units (BP)

**Decoration**

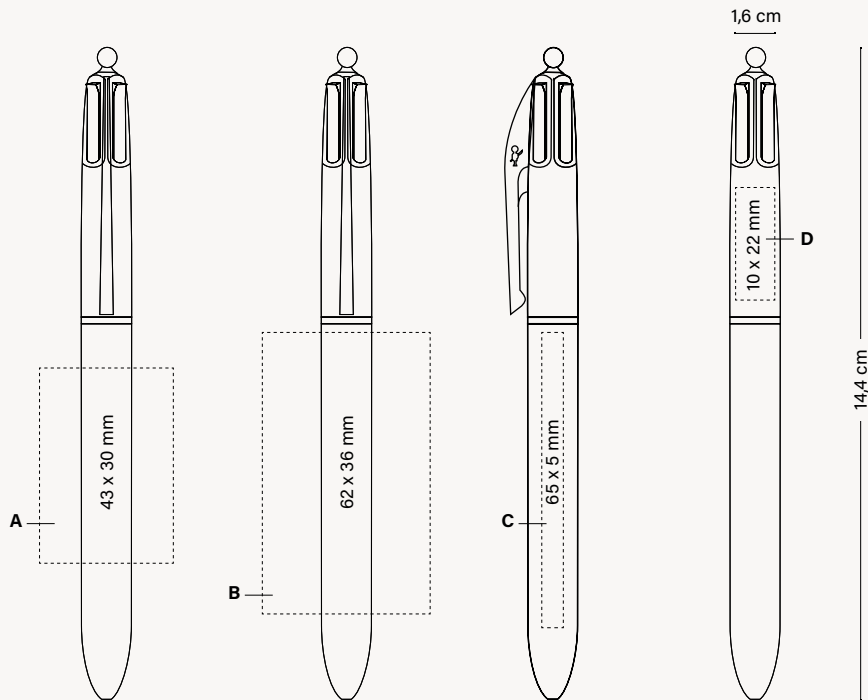

**WRITING MODES**



**PRINTING TECHNIQUES**



**SUSTAINABILITY**

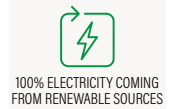

**OPTIONAL SPECIAL PACKAGING**



+ INFO PAGES 262 TO 266

*Can be used as bookmark*

*Collection Box (1, 2 & 3 units)*

**EXTERNAL PACKAGING**



BIC GRAPHIC

BIC® WRITING INSTRUMENTS

OTHER WRITING INSTRUMENTS

NOTEBOOKS

BIC® / D/EEP® LIGHTERS AND BIC® CASES

BIC® PACKAGING

GENERAL INFORMATION

See pages 274-277 for a detailed explanation of the icons.

BIC® 4 COLOURS® RAINBOW DECOR

# Colour Your World!

Your Life, Your Style

1123 / 1124

**BIC® 4 COLOURS® RAINBOW DECOR**

1123

1124 With Lanyard

Colour ink



**NEW!**

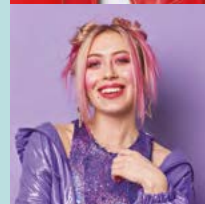
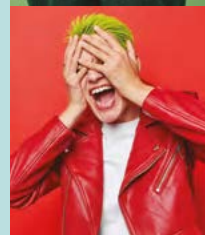
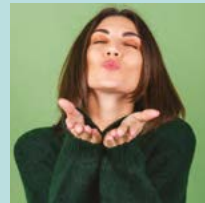

Refill  
service on  
request

01/9Y

FR

**Colorez votre  
monde !**

Votre vie, votre style

DE

**Bringe Farbe  
in deine Welt!**

Dein Leben, dein Stil

IT

**Colora il tuo  
mondo!**

La tua vita, il tuo stile

ES

**¡Colorea  
tu mundo!**

Tu vida, tu estilo

1123 / 1124

**BIC® 4 COLOURS® RAINBOW DECOR**  
1123/1124

**A SP:** max. 2 col.  
**B SP:** max. 1 col.

MOQ 250 units (SP)

**Decoration**

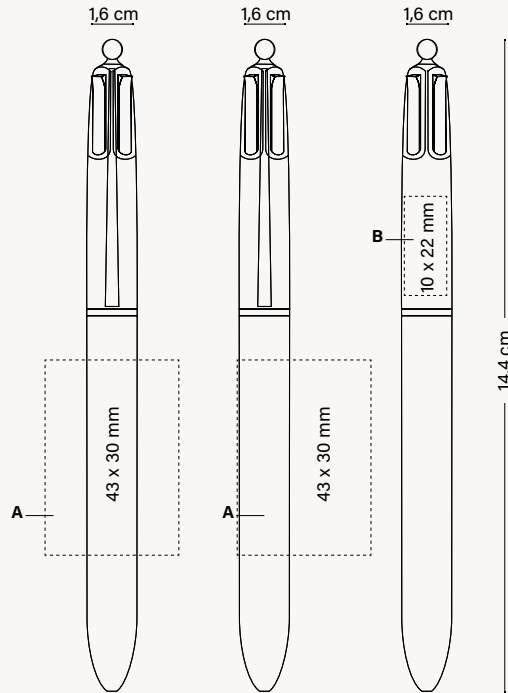

**OPTIONAL SPECIAL PACKAGING**



ECO SLEEVE

+ INFO PAGES 262 TO 266



PLASTIC POUCH

*Can be used as bookmark*



WINDOW BOX



COLLECTION BOX

*Collection Box (1, 2 & 3 units)*



**EXTERNAL PACKAGING**

250 ± 3,2KG



PERSONALIZED COLOURS



MANUFACTURED AND PRINTED IN BIC FACTORIES



FABRIQU  EN FRANCE  
MADE IN FRANCE



REGULATORY COMPLIANCE



ISO certified

WRITING MODES



BALLPEN M  
Ø 1 MM

PRINTING TECHNIQUES



SCREEN PRINTING

SUSTAINABILITY



IMPRIM'VERT®



100% ELECTRICITY COMING FROM RENEWABLE SOURCES



CHECK OUT THE VIDEO

See pages 274-277 for a detailed explanation of the icons.

BIC GRAPHIC

BIC WRITING INSTRUMENTS

OTHER WRITING INSTRUMENTS

NOTEBOOKS

BIC / DEEP LIGHTERS AND BIC CASES

BIC PACKAGING

GENERAL INFORMATION

BIC® 4 COLOURS® BICOLOR

# Metallic aesthetics with an artistic touch.

1069 / 1076

BIC® 4 COLOURS® BICOLOR

1069

1076 With Lanyard

Colour ink



01/04G/47

01/05G/47

01/80/47

01/4R/47



Refill  
service on  
request

FR  
Une esthétique  
métallique avec une  
touche artistique.

DE  
Ein Metallic-Look mit  
künstlerischer Note.

IT  
Look metallico con  
un tocco artistico.

ES  
Estética metálica  
con un toque  
artístico.

1069 / 1076

**BIC® 4 COLOURS® BICOLOR®**  
1069/1076

**A SP:** max. 2 col.  
**B SP:** max. 1 col.

MOQ 250 units

### Decoration

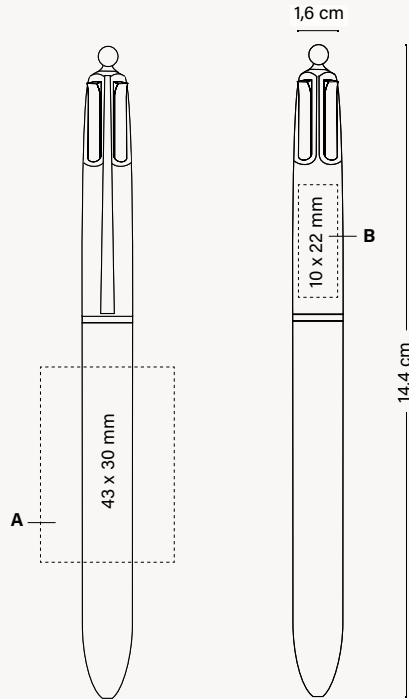

WRITING MODES



PRINTING TECHNIQUES



SUSTAINABILITY



### OPTIONAL SPECIAL PACKAGING



+ INFO PAGES 262 TO 266

*Can be used as bookmark*

*Collection Box (1, 2 & 3 units)*

### EXTERNAL PACKAGING



CHECK OUT THE VIDEO

See pages 274-277 for a detailed explanation of the icons.

## BIC® 4 COLOURS® GRADIENT

# The most summery vibes.

1074 / 1075

**BIC® 4 COLOURS® GRADIENT**

1074

1075 With Lanyard

Colour ink



Refill  
service on  
request

01/3G/8D/4R

FR  
Un look  
total d'été.

DE  
Die beste  
Sommer-Stimmung.

IT  
Un'esplosione di  
colori estivi.

ES  
La vibraciones  
más veraniegas.

Decoration

1074 / 1075

**BIC® 4 COLOURS® GRADIENT**

1074/1075

**A SP:** max. 2 col.  
**B SP:** max. 1 col.

MOQ 250 units

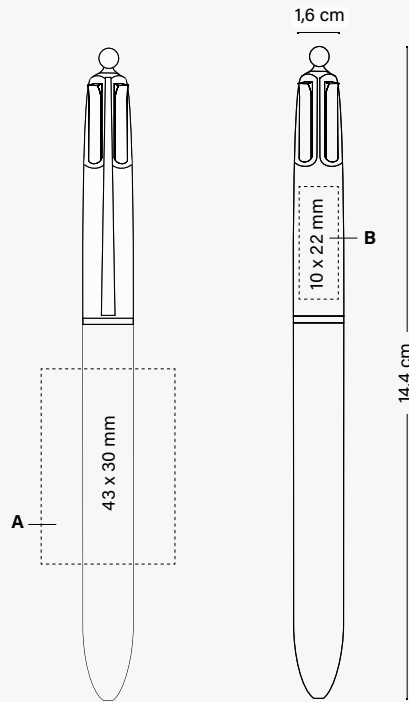

**OPTIONAL SPECIAL PACKAGING**



+ INFO PAGES 262 TO 266



*Can be used as bookmark*



*Collection Box (1, 2 & 3 units)*

**EXTERNAL PACKAGING**



PERSONALIZED COLOURS



MANUFACTURED AND PRINTED IN BIC FACTORIES



MADE IN FRANCE



REGULATORY COMPLIANCE



ISO certified

**WRITING MODES**



BALLPEN M 0.1 MM

**PRINTING TECHNIQUES**



SCREEN PRINTING

**SUSTAINABILITY**



IMPRIM'VERT®



100% ELECTRICITY COMING FROM RENEWABLE SOURCES



CHECK OUT THE VIDEO

See pages 274-277 for a detailed explanation of the icons.

BIC GRAPHIC

BIC WRITING INSTRUMENTS

OTHER WRITING INSTRUMENTS

NOTEBOOKS

BIC / DLEEP LIGHTERS AND BIC CASES

BIC PACKAGING

GENERAL INFORMATION

## BIC® 4 COLOURS® PASTEL

# Vintage colours, dreamy imagery.

1071 / 1072

### BIC® 4 COLOURS® PASTEL

1071 Opaque

1072 With Lanyard

Colour ink



Refill  
service on  
request

FR  
Des couleurs  
vintages,  
tout un rêve.

DE  
Vintage-Farben,  
eine verträumte  
Bildsprache.

IT  
Colori vintage,  
immagini da  
sogno.

ES  
Colores vintage  
de ensueño.

1071 / 1072

**BIC® 4 COLOURS® PASTEL**

1071/1072

**A SP:** max. 4 col.  
**B DG:** Digital print

MOQ 250 units

**Decoration**

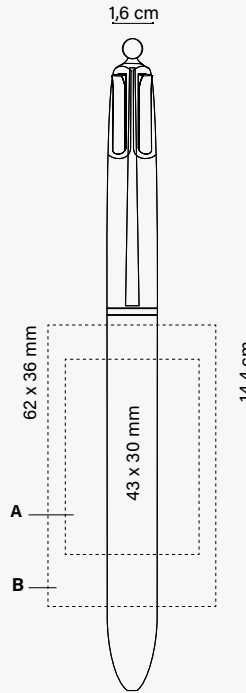

PERSONALIZED COLOURS



MANUFACTURED AND PRINTED IN BIC FACTORIES



MADE IN FRANCE



REGULATORY COMPLIANCE



WRITING MODES



BALLPEN M  
Ø 1 MM

PRINTING TECHNIQUES



SCREEN PRINTING



DIGITAL

SUSTAINABILITY



IMPRIM'VERT®



100% ELECTRICITY COMING FROM RENEWABLE SOURCES

**OPTIONAL SPECIAL PACKAGING**

**EXTERNAL PACKAGING**



ECO SLEEVE

+ INFO PAGES 262 TO 266



PLASTIC POUCH

*Can be used as bookmark*



WINDOW BOX



*Collection Box (1, 2 & 3 units)*



250 ± 3,2KG



CHECK OUT THE VIDEO

See pages 274-277 for a detailed explanation of the icons.

BIC GRAPHIC

BIC® WRITING INSTRUMENTS

OTHER WRITING INSTRUMENTS

NOTEBOOKS

BIC® / DLEEP® LIGHTERS AND BIC® CASES

BIC® PACKAGING

GENERAL INFORMATION



THE SOLUTION FOR FULL COLOUR COMMUNICATION!

Now on coloured barrels

1102 / 1108

**BIC® 4 COLOURS® FASHION**

1102 Opaque

1108 With Lanyard

Colour ink



01/01

01/84

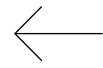

Fashion inks!

360° Printing



Refill service on request

100%

01/24

1102 / 1108

**BIC® 4 COLOURS® FASHION**  
1102/1108

- A SP:** max. 4 col.
- B DG:** Digital print (area for images)
- C BP:** full-colour
- D SP:** max. 1 col.

MOQ 250 units (SP, DG)  
MOQ 100 units (BP)

**Decoration**

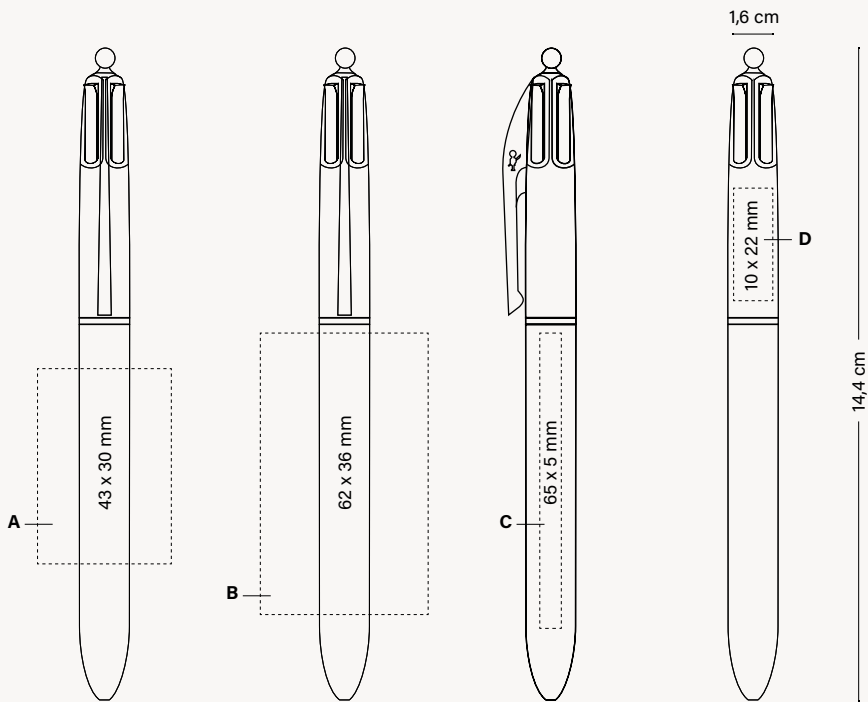

**OPTIONAL SPECIAL PACKAGING**



+ INFO PAGES 262 TO 266



*Can be used as bookmark*



*Collection Box (1, 2 & 3 units)*

**EXTERNAL PACKAGING**



PERSONALIZED COLOURS



MANUFACTURED AND PRINTED IN BIC FACTORIES



MADE IN FRANCE



REGULATORY COMPLIANCE



**WRITING MODES**



BALLPEN M Ø 1 MM

**PRINTING TECHNIQUES**



SCREEN PRINTING



BRITEPIX™  
BRITEPIX™ TEXTURE  
BRITEPIX™ PERSONALISATION

**SUSTAINABILITY**



100% ELECTRICITY COMING FROM RENEWABLE SOURCES

BIC GRAPHIC

BIC® WRITING INSTRUMENTS

OTHER WRITING INSTRUMENTS

NOTEBOOKS

BIC® / DLEEP® LIGHTERS AND BIC® CASES

BIC® PACKAGING

GENERAL INFORMATION

See pages 274-277 for a detailed explanation of the icons.



THE SOLUTION  
FOR FULL COLOUR  
COMMUNICATION!

1097 / 1098

**BIC® 4 COLOURS® SUN**

1097 Opaque

1098 With Lanyard

Colour ink



*Flashy colours:  
orange & yellow*



01/12



Refill  
service on  
request

100%

01/12

1097 / 1098

**BIC® 4 COLOURS® SUN**

1097/1098

**A SP:** max. 4 col.

**B DG:** Digital print (area for images)

**C BP:** full-colour

**D SP:** max. 1 col.

MOQ 250 units (SP, DG)

MOQ 100 units (BP)

**Decoration**

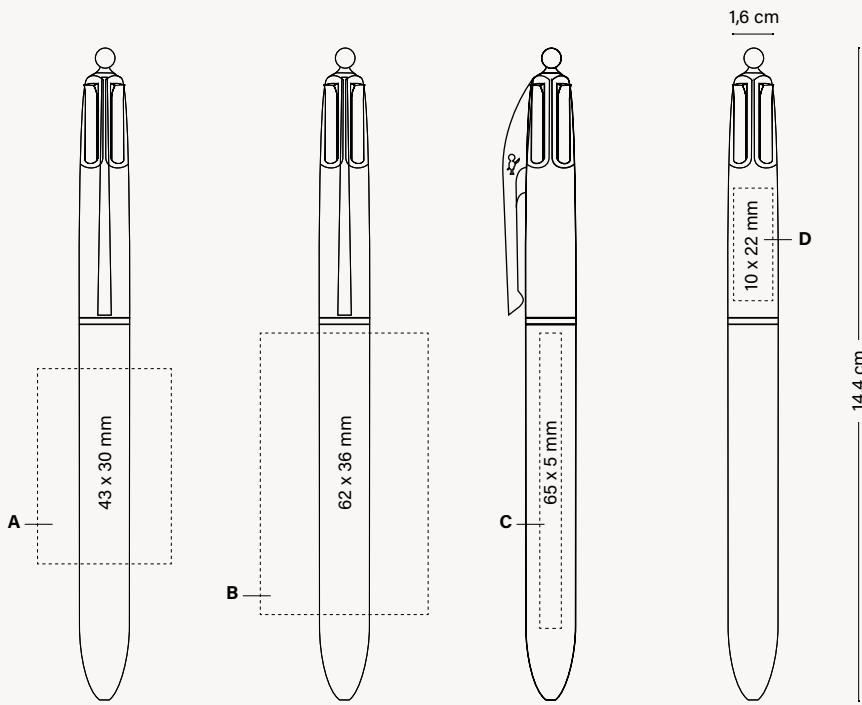

**OPTIONAL SPECIAL PACKAGING**



ECO SLEEVE

+ INFO PAGES 262 TO 266



PLASTIC POUCH

Can be used as bookmark



WINDOW BOX



COLLECTION BOX

Collection Box (1, 2 & 3 units)

**EXTERNAL PACKAGING**



250 ± 3,2KG



PERSONALIZED COLOURS



MANUFACTURED AND PRINTED IN BIC FACTORIES



MADE IN FRANCE



REGULATORY COMPLIANCE



**WRITING MODES**



BALLPEN M Ø 1 MM

**PRINTING TECHNIQUES**



SCREEN PRINTING



DIGITAL



BRITEPIX™  
BRITEPIX™ TEXTURE  
BRITEPIX™ PERSONALISATION

**SUSTAINABILITY**



IMPRIM'VERT®



100% ELECTRICITY COMING FROM RENEWABLE SOURCES

See pages 274-277 for a detailed explanation of the icons.

**britePix**  
**DIGITAL** THE SOLUTION  
FOR FULL COLOUR  
COMMUNICATION!

1109 / 1111

**BIC® 4 COLOURS® FINE**

1109 Opaque  
1111 With Lanyard

Colour ink  
●●●●



1109 / 1111

**BIC® 4 COLOURS® FINE**

1109/1111

- A SP:** max. 4 col.
- B DG:** Digital print
- C BP:** full-colour
- D SP:** max. 1 col.

MOQ 250 units (SP, DG)  
 MOQ 100 units (BP)

**Decoration**

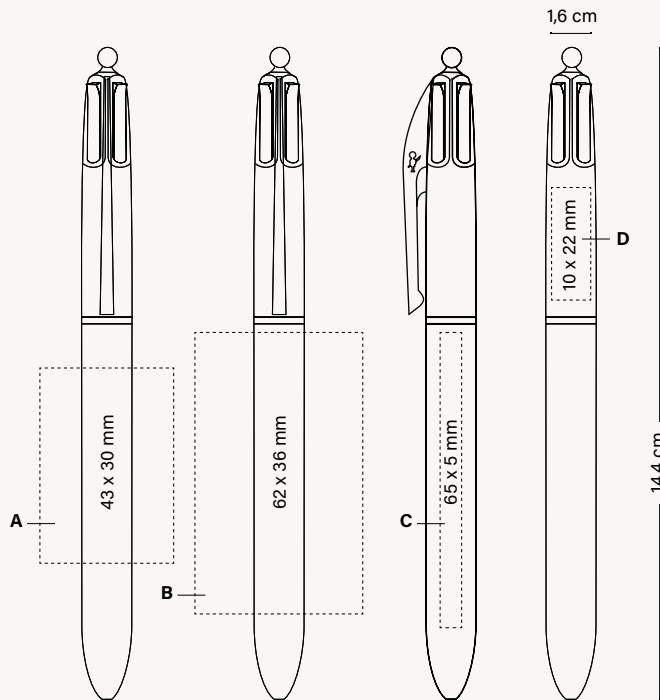

PERSONALIZED COLOURS



MANUFACTURED AND PRINTED IN BIC FACTORIES



MADE IN FRANCE



REGULATORY COMPLIANCE



**WRITING MODES**



BALLPEN M  
Ø 0,8 MM

**PRINTING TECHNIQUES**



SCREEN PRINTING



DIGITAL



BRITEPIX™  
BRITEPIX™ TEXTURE  
BRITEPIX™ PERSONALISATION

**SUSTAINABILITY**



IMPRIM'VERT®



100% ELECTRICITY COMING FROM RENEWABLE SOURCES

**OPTIONAL SPECIAL PACKAGING**



ECO SLEEVE



PLASTIC POUCH



WINDOW BOX



COLLECTION BOX

+ INFO PAGES 262 TO 266

*Can be used as bookmark*

*Collection Box (1, 2 & 3 units)*

**EXTERNAL PACKAGING**



250 ± 3,2KG

See pages 274-277 for a detailed explanation of the icons.

BIC GRAPHIC

BIC WRITING INSTRUMENTS

OTHER WRITING INSTRUMENTS

NOTEBOOKS

BIC / DLEEP® LIGHTERS AND BIC® CASES

BIC® PACKAGING

GENERAL INFORMATION

1114 / 1116

**BIC® 4 COLOURS® FLUO**

1114 Opaque

1116 With Lanyard

Colour ink



4 inks, one of them fluo!



Refill service on request

100%

01/4D

01/4D

1114 / 1116

**BIC® 4 COLOURS® FLUO**

1114/1116

**A SP:** max. 4 col.

**B BP:** full-colour

**C SP:** max. 1 col.

MOQ 250 units (SP)

MOQ 100 units (BP)

**Decoration**

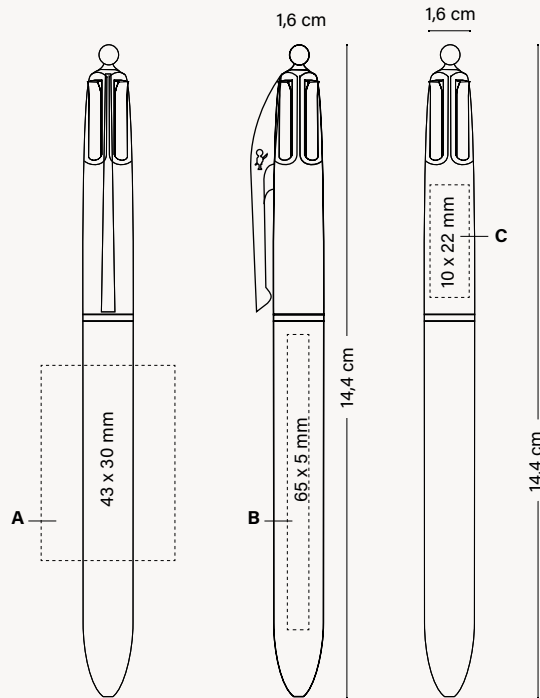

**OPTIONAL SPECIAL PACKAGING**



ECO SLEEVE



PLASTIC POUCH



WINDOW BOX



COLLECTION BOX

+ INFO PAGES 262 TO 266

*Can be used as bookmark*

*Collection Box (1, 2 & 3 units)*

**EXTERNAL PACKAGING**



250 ± 3,2KG



PERSONALIZED COLOURS



MANUFACTURED AND PRINTED IN BIC FACTORIES



MADE IN FRANCE



REGULATORY COMPLIANCE



ISO certified

**WRITING MODES**



BALLPEN M Ø 1 MM

**PRINTING TECHNIQUES**



SCREEN PRINTING



BRITEPIX™  
BRITEPIX™ TEXTURE  
BRITEPIX™ PERSONALISATION

**SUSTAINABILITY**



IMPRIM'VEERT®



100% ELECTRICITY COMING FROM RENEWABLE SOURCES

See pages 274-277 for a detailed explanation of the icons.

# BIC® 4 COLOURS® GLACÉ

## Our classic pen dressed up.

1057 / 1058

**BIC® 4 COLOURS® GLACÉ**

1057

1058 With Lanyard

Colour ink



01/76

01/47G

01/03G

01/05G

01/04G

02/47G

02/76

01/14G



Refill  
service on  
request

FR

Notre stylo  
classique dans  
sa plus belle tenue

DE

Unser klassischer  
Kugelschreiber  
kleidet sich festlich

IT

La nostra penna  
iconica in abito  
elegante

ES

Nuestro bolígrafo  
clásico se viste  
de gala

1057 / 1058

**BIC® 4 COLOURS® GLACÉ**

1057/1058

**A SP:** max. 2 col.

**B SP:** max. 1 col. (only for white upper parts)

MOQ 250 units

**Decoration**

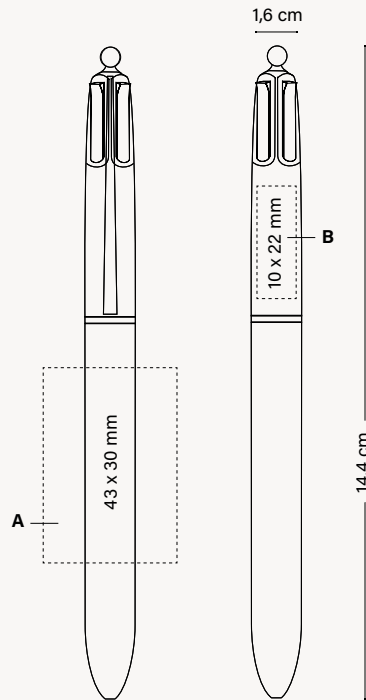

PERSONALIZED COLOURS



MANUFACTURED AND PRINTED IN BIC FACTORIES



FABRIQU  EN FRANCE  
MADE IN FRANCE



REGULATORY COMPLIANCE



ISO certified

WRITING MODES



BALLPEN M  
0.1 MM

PRINTING TECHNIQUES



SP  
SCREEN PRINTING

SUSTAINABILITY



IMPRIM'VERT®



100% ELECTRICITY COMING FROM RENEWABLE SOURCES

**OPTIONAL SPECIAL PACKAGING**



ECO SLEEVE

+ INFO PAGES 262 TO 266



PLASTIC POUCH

*Can be used as bookmark*



WINDOW BOX



COLLECTION BOX

*Collection Box (1, 2 & 3 units)*

**EXTERNAL PACKAGING**



250 ± 3,2KG

See pages 274-277 for a detailed explanation of the icons.

1106 / 1107

**BIC® 4 COLOURS® SHINE**

1106

1107 With Lanyard

Colour ink



01/75



01/26



01/7G



01/34



01/97

*Super Shiny barrels!*



Refill service on request

100%

1106 / 1107

**BIC® 4 COLOURS® SHINE**

1106/1107

**A SP:** max. 2 col.

**B LE**

**C LE**

**D LE:** 360°

**E SP:** max. 1 col.

MOQ 250 units

**Decoration**

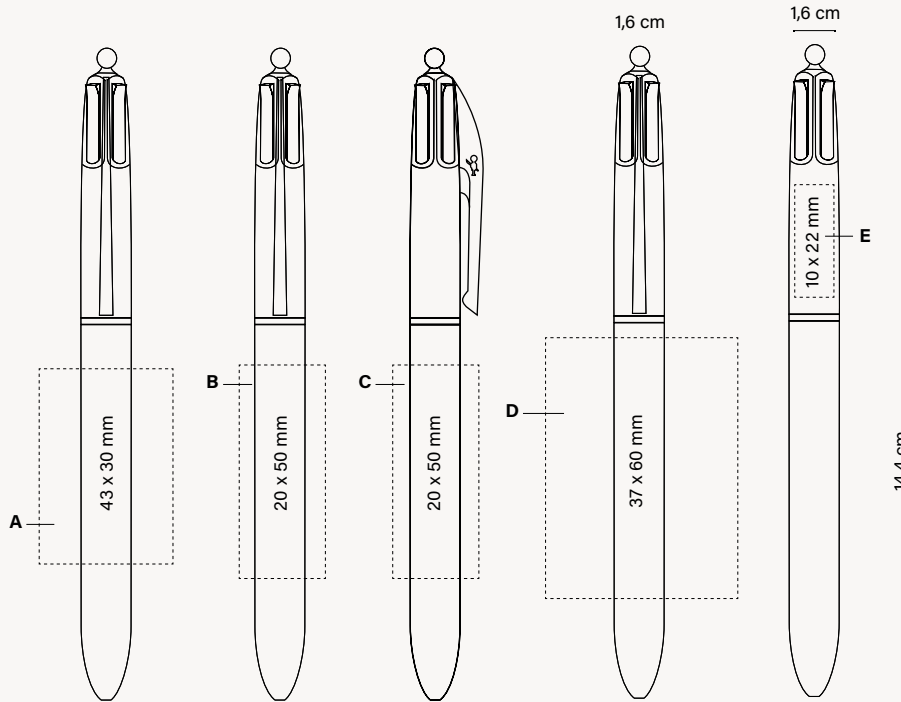

**WRITING MODES**



**PRINTING TECHNIQUES**



**SUSTAINABILITY**



**OPTIONAL SPECIAL PACKAGING**

**EXTERNAL PACKAGING**



+ INFO PAGES 262 TO 266



*Can be used as bookmark*



*Collection Box (1, 2 & 3 units)*



250 ± 3,2KG

See pages 274-277 for a detailed explanation of the icons.

BIC® 4 COLOURS® SOFT



# A soft touch you won't want to put down!

1060 / 1063

**BIC® 4 COLOURS® SOFT**  
1060 Opaque  
1063 With Lanyard

Colour ink  



01/03F

01/02F

02/02F

01/07F

FR  
**Un toucher doux que vous ne lâcherez plus !**

DE  
**Ein sanftes Gefühl, das Sie nicht mehr aus der Hand legen möchten.**

IT  
**Una superficie morbida che non vorrai mai smettere di toccare!**

ES  
**¡Un tacto suave que no querrás dejar de tocar!**

1060 / 1063

**BIC® 4 COLOURS® SOFT**

1060/1063

**A SP:** max. 1 col.

**B SP:** max. 1 col. (only for white upper parts)

MOQ 250 units

**Decoration**

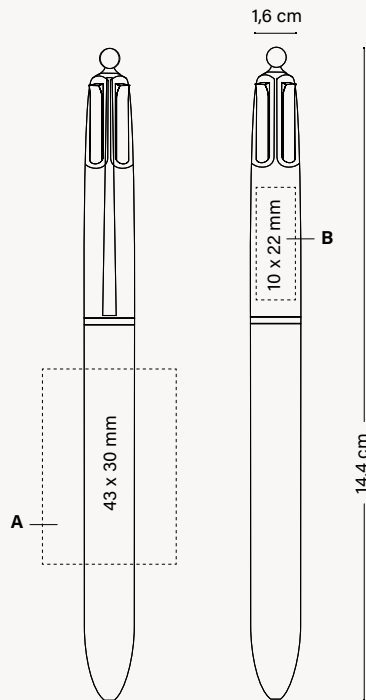

PERSONALIZED COLOURS



MANUFACTURED AND PRINTED IN BIC FACTORIES



FABRIQU  EN FRANCE  
MADE IN FRANCE



REGULATORY COMPLIANCE



WRITING MODES



BALLPEN M  
0.1 MM

PRINTING TECHNIQUES



SCREEN PRINTING

SUSTAINABILITY



IMPRIM'VERT®



100% ELECTRICITY COMING FROM RENEWABLE SOURCES

**OPTIONAL SPECIAL PACKAGING**



ECO SLEEVE

+ INFO PAGES 262 TO 266



PLASTIC POUCH

*Can be used as bookmark*



WINDOW BOX



COLLECTION BOX

*Collection Box (1, 2 & 3 units)*

**EXTERNAL PACKAGING**



250 ± 3,2KG

See pages 274-277 for a detailed explanation of the icons.

BIC GRAPHIC

BIC® WRITING INSTRUMENTS

OTHER WRITING INSTRUMENTS

NOTEBOOKS

BIC® / DLEEP® LIGHTERS AND BIC® CASES

BIC® PACKAGING

GENERAL INFORMATION

**BIC® 4 COLOURS® WOOD STYLE**



# Be impressed with the spectacular wood finish!

1061 / 1064

**BIC® 4 COLOURS® WOOD STYLE**

1061 Opaque

1064 With Lanyard

Colour ink



01/6AW

01/05W

01/02W

02/6AW

01/12W



*Bring warmth to your brand*



Refill service on request

FR  
**Laissez-vous impressionner par cette finition spectaculaire !**

DE  
**Lassen Sie sich von der spektakulären Holzoptik beeindrucken!**

IT  
**Lasciati impressionare dalla spettacolare finitura in legno!**

ES  
**¡Déjate impresionar por el espectacular acabado efecto madera!**

1061 / 1064

**BIC® 4 COLOURS® WOOD STYLE**

1061/1064

**A SP:** max. 2 col.

**B SP:** max. 1 col. (only for white upper parts)

MOQ 250 units

**Decoration**

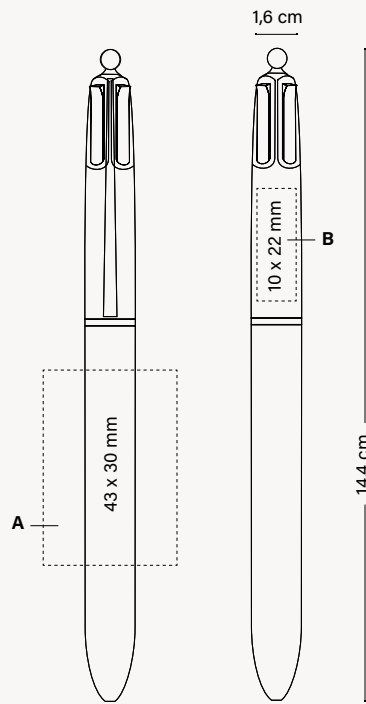

PERSONALIZED COLOURS



MANUFACTURED AND PRINTED IN BIC FACTORIES



MADE IN FRANCE



REGULATORY COMPLIANCE



WRITING MODES



BALLPEN M  
Ø 1 MM

PRINTING TECHNIQUES



SCREEN PRINTING

SUSTAINABILITY



IMPRIM'VERT®



100% ELECTRICITY COMING FROM RENEWABLE SOURCES

**OPTIONAL SPECIAL PACKAGING**



ECO SLEEVE

+ INFO PAGES 262 TO 266



PLASTIC POUCH

*Can be used as bookmark*



WINDOW BOX



COLLECTION BOX

*Collection Box (1, 2 & 3 units)*

**EXTERNAL PACKAGING**



250 ± 3,2KG

See pages 274-277 for a detailed explanation of the icons.

**BIC® 4 COLOURS® FLAGS COLLECTION**

**Celebrate heritage.**

1067 / 1068

**BIC® 4 COLOURS® FLAGS COLLECTION**

1067

1068 With Lanyard

Colour ink



01/03/47/05



01/02/03/12



02/02/03/12



01/03/47/04



01/03/12/03



Refill  
service on  
request

FR  
**Célébrer le  
patrimoine !**

DE  
**Feiern Sie Ihre  
Geschichte!**

IT  
**Celebra il  
patrimonio!**

ES  
**¡Celebra  
el legado!**

1067 / 1068

**BIC® 4 COLOURS® FLAGS COLLECTION**

1067/1068

**A SP:** max. 2 col.

**B SP:** max. 1 col. (only for white upper parts)

MOQ 250 units

**Decoration**

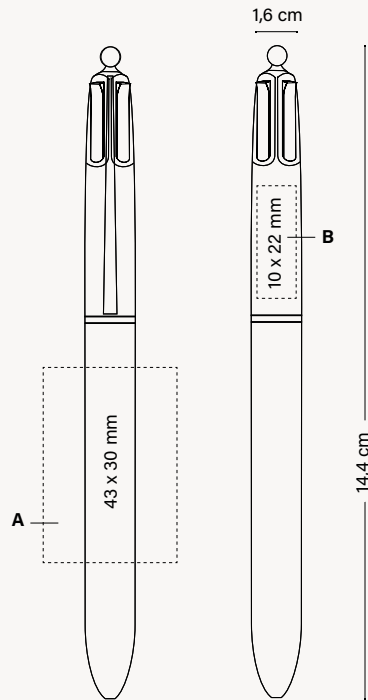

PERSONALIZED COLOURS



MANUFACTURED AND PRINTED IN BIC FACTORIES



MADE IN FRANCE



REGULATORY COMPLIANCE



WRITING MODES



BALLPEN M  
Ø 1 MM

PRINTING TECHNIQUES



SCREEN PRINTING

SUSTAINABILITY



IMPRIM'VERT®



100% ELECTRICITY COMING FROM RENEWABLE SOURCES

**OPTIONAL SPECIAL PACKAGING**



ECO SLEEVE

+ INFO PAGES 262 TO 266



PLASTIC POUCH

*Can be used as bookmark*



WINDOW BOX



COLLECTION BOX

*Collection Box (1, 2 & 3 units)*

**EXTERNAL PACKAGING**



250 ± 3,2KG



CHECK OUT THE VIDEO

See pages 274-277 for a detailed explanation of the icons.

BIC GRAPHIC

BIC WRITING INSTRUMENTS

OTHER WRITING INSTRUMENTS

NOTEBOOKS

BIC / DEEP LIGHTERS AND BIC CASES

BIC PACKAGING

GENERAL INFORMATION

1099

**BIC® 4 COLOURS® 3+1<sup>HB</sup>**  
1099 Opaque

Colour ink  
●●●●

3 ballpens +  
1 mechanical pencil.



  
Refill  
service on  
request

1099

**BIC® 4 COLOURS® 3+1<sup>HB</sup>**

1099 Opaque

**A/B LE**

MOQ 250 units

**Decoration**

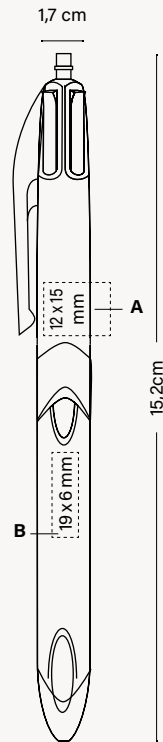

PERSONALIZED COLOURS



MANUFACTURED AND PRINTED IN BIC FACTORIES



REGULATORY COMPLIANCE



ISO certified

**WRITING MODES**



BALLPEN M  
Ø 1 MM



MECHANICAL PENCIL  
MP Ø 0,7MM

**PRINTING TECHNIQUES**



LASER

**SUSTAINABILITY**



IMPRIM'VERT®



100% ELECTRICITY COMING FROM RENEWABLE SOURCES

**OPTIONAL SPECIAL PACKAGING**



PLASTIC POUCH

+ INFO PAGES 262 TO 266

*Can be used as bookmark*



COLLECTION BOX

*Collection Box (1, 2 & 3 units)*

**EXTERNAL PACKAGING**



250 ± 3,5 KG



CHECK OUT THE VIDEO

See pages 274-277 for a detailed explanation of the icons.

BIC GRAPHIC

BIC® WRITING INSTRUMENTS

OTHER WRITING INSTRUMENTS

NOTEBOOKS

BIC® / DLEEP® LIGHTERS AND BIC® CASES

BIC® PACKAGING

GENERAL INFORMATION

BIC® METAL PRO

# Metal accents and modern design, available in classic colors and a variety of finishes.

1290

BIC® METAL PRO

1290 Soft

Colour ink



01F



02F



04F



*Maximum writing comfort*



*German ink for writing up to 8 km.*

FR

Des accents métalliques et un design moderne, disponible en couleurs classiques et une variété de finitions.

DE

Metallakzente und modernes Design, erhältlich in klassischen Farben und einer Vielzahl von Ausführungen.

IT

Particolari metallici, design moderno, disponibili in colori classici e una varietà di finiture.

ES

Detalles metálicos y diseño moderno, disponible en colores clásicos y una variedad de acabados.

1290

**BIC® METAL PRO**  
1290 Polished

Colour ink  
● ●



01E



02E



04E

100%

  
ASSEMBLED  
AND PRINTED IN  
BIC FACTORIES

  
MADE IN EUROPE

  
REGULATORY  
COMPLIANCE

  
ISO  
certified

**WRITING  
MODES**

  
BALLPEN M  
Ø 1 MM

**PRINTING  
TECHNIQUES**

  
SCREEN PRINTING

  
LASER

**SUSTAINABILITY**

  
IMPRIM'VERT®

See pages 274-277 for a detailed explanation of the icons

1290

**BIC® METAL PRO**

1290 Matt

Colour ink



01D



02D



04D

100%

1290

**BIC® METAL PRO**

1290

**A SP:** max. 2 col.  
(Not available in soft finish)

**B LE/SP:** max. 1 col.

**C LE 360°**

MOQ 50 units

**Decoration**



**WRITING MODES**



**PRINTING TECHNIQUES**



**SUSTAINABILITY**

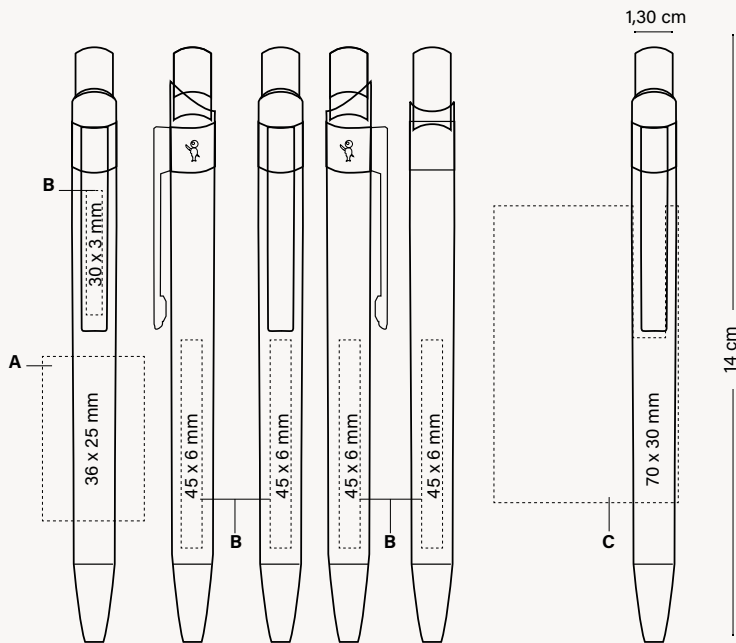

**OPTIONAL SPECIAL PACKAGING**



+ INFO PAGES 262 TO 266

**EXTERNAL PACKAGING**



See pages 274-277 for a detailed explanation of the icons

# BIC® ROLLERS AND GELS

**Enjoy a smooth writing experience. Glide across the paper easily without smudging thanks to the quick-drying ink, ideal for both left and right-handed people.**

FR

Profitez d'une expérience d'écriture douce, fluide et de longue durée. Parfait pour les droitiers comme pour les gauchers, il glisse facilement sur le papier et ne fait pas de tâches grâce à son encre à séchage rapide.

DE

Genießen Sie das sanfte Schreiberlebnis. Gleitet leicht über das Papier und dank der schnell trocknenden Tinte, ohne zu verschmieren. Ideal für Links- und Rechtshänder.

IT

Goditi un'esperienza di scrittura morbidissima. Scorre facilmente sulla carta senza macchiare grazie all' inchiostro ad asciugatura immediata, ideale per mancini.

ES

Disfruta de una experiencia de escritura suave, fluida y de larga duración. Se desliza fácilmente a través del papel y sin manchas gracias a la tinta de secado rápido, ideal tanto para las personas zurdas como diestras.



**BIC® GRIP ROLLER**  
**BIC® XS FINESTYLE**  
**BIC® INTENSITY® GEL CLIC**



# BIC® GRIP ROLLER

1187



MEDIUM WRITING  
Ø 0,7 MM

*High quality medium point liquid ink roller pen for smooth and fluid writing*

## BIC® GRIP ROLLER

1187

Colour ink



01/35

12/35

10/35

03/35

59/35

24/35

07/35

06/35

27/35

02/35

14/35

●  
Also available  
in blue ink

●  
Also available  
in blue ink

●  
Also available  
in blue ink

100%

1187

**BIC® GRIP ROLLER**

1187

A/B SP: max. 3 col.

MOQ 250 units

**Decoration**

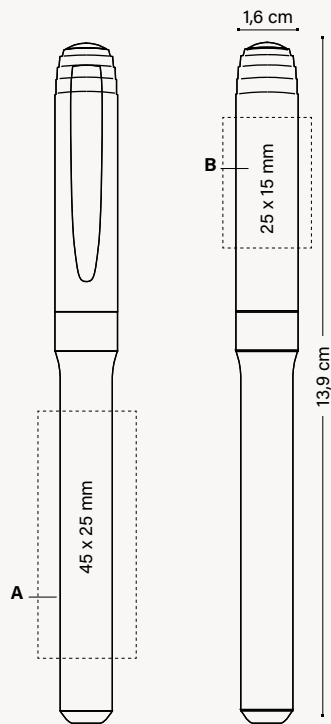

**OPTIONAL SPECIAL PACKAGING**



+ INFO PAGES 262 TO 266



*Can be used as bookmark*

*Collection Box (1, 2 & 3 units)*

**EXTERNAL PACKAGING**



250 ± 3 KG

BIC GRAPHIC

BIC® WRITING INSTRUMENTS

OTHER WRITING INSTRUMENTS

NOTEBOOKS

BIC® / DJEOP® LIGHTERS AND BIC® CASES

BIC® PACKAGING

GENERAL INFORMATION

See pages 274-277 for a detailed explanation of the icons

1851

**BIC® XS FINESTYLE**  
1851 Opaque

Colour ink  
●



01/03



01/25



01/06

●  
Only available  
in black ink

1851

**BIC® XS FINESTYLE**  
1851 Clear

Colour ink  
●



89/01

100%

1851

**BIC® XS FINESTYLE**

1851

**A PD:** max. 2 col.

**B SP:** max. 2 col.

**C BP:** full-colour

MOQ 250 units

**Decoration**

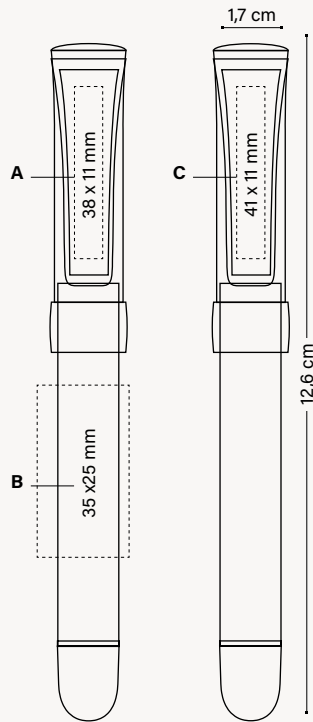

**WRITING MODES**



**PRINTING TECHNIQUES**



**SUSTAINABILITY**



**OPTIONAL SPECIAL PACKAGING**



+ INFO PAGES 262 TO 266



*Can be used as bookmark*

**EXTERNAL PACKAGING**



1196



*Iconic BIC® Boy  
is embossed*

**BIC® INTENSITY®  
GEL CLIC**

1196 Opaque

Colour ink



01



02

100%

1196

**BIC® INTENSITY®  
GEL CLIC**

1196 Clear

Colour ink



92



88



86

100%

1196

**BIC® INTENSITY® GEL CLIC**

1196

**A SP:** max. 2 col.

**B SP:** max. 4 col.

MOQ 250 units

**Decoration**

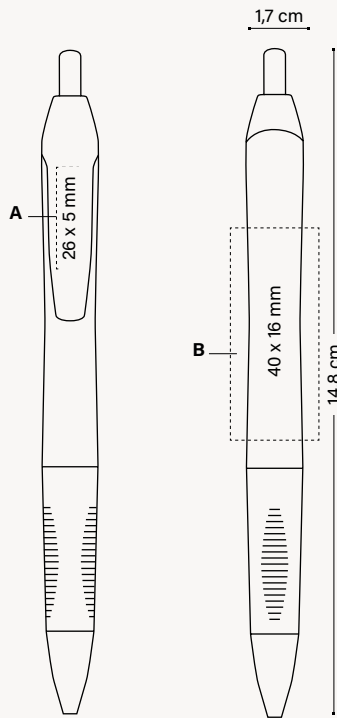

**OPTIONAL SPECIAL PACKAGING**



PLASTIC  
POUCH

+ INFO PAGES 262 TO 266

**EXTERNAL PACKAGING**



250 ± 3,7KG



**WRITING  
MODES**



**PRINTING  
TECHNIQUES**



**SUSTAINABILITY**



BIC  
GRAPHIC

BIC®  
WRITING INSTRUMENTS

OTHER WRITING  
INSTRUMENTS

NOTEBOOKS

BIC® / DLEEP® LIGHTERS  
AND BIC® CASES

BIC®  
PACKAGING

GENERAL  
INFORMATION

See pages 274-277 for a detailed explanation of the icons

# BIC® HIGHLIGHTERS AND MARKERS

---

**BIC® Markers offer you products specifically designed to write in a highly visible way and mark on surfaces or material that other writing instruments cannot mark on. Make your ideas visible and express yourself whatever the surface with BIC® Markers.**

FR

Les surligneurs et les marqueurs BIC® ont été conçus pour écrire d'une manière visible sur une large gamme de surfaces. Exprimez-vous avec clarté sur n'importe quelle surface.

DE

BIC®-Textmarker sind Produkte, die speziell konzipiert wurden, um besonders sichtbar zu schreiben und auf Oberflächen oder Materialien zu markieren, wo herkömmliche Schreibgeräte möglicherweise an ihre Grenzen stoßen.

IT

BIC® ti offre prodotti appositamente progettati per scrivere in modo ben visibile su superfici e materiali su cui altri strumenti di scrittura non possono scrivere. Rendi visibili le tue idee ed esprimiti su qualsiasi superficie con pennarelli BIC®.

ES

Los resaltadores y marcadores BIC® están diseñados para escribir visiblemente en un amplio rango de superficies. Exprésate con claridad sin importar la superficie.



- BIC® BRITE LINER® GRIP**
- BIC® VELLEDA® WHITE BOARD MARKER FINE**
- BIC® VELLEDA® WHITE BOARD MARKER GRIP**
- BIC® MARK-IT PERMANENT MARKER**
- BIC® PERMANENT MARKER ECOLUTIONS®**



1192

BIC® BRITE LINER® GRIP  
1192



12



Colour ink

10



Colour ink

24



Colour ink

59



Colour ink

14



Colour ink

100%



*Textured rubberised grip for more precision and control*

1192

**BIC® BRITE LINER® GRIP**

1192

A/B SP: max. 3 col.

MOQ 250 units

**Decoration**

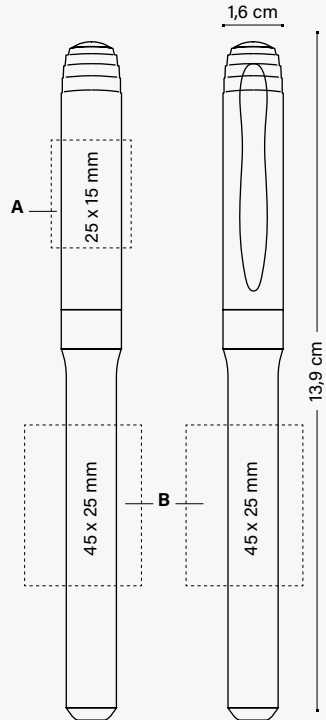

MANUFACTURED AND PRINTED IN BIC FACTORIES

FABRIQUÉ EN FRANCE  
MADE IN FRANCE

REGULATORY COMPLIANCE

ISO certified

WILL NOT DRY OUT IN 24H

WRITING MODES

HIGHLIGHTER HL

PRINTING TECHNIQUES

SP  
SCREEN PRINTING

SUITABLE FOR

FAXES

PHOTOCOPIES

PRINTERS

PAPER

SUSTAINABILITY

IMPRIM'VERT®

**OPTIONAL SPECIAL PACKAGING**



MARKING SET

+ INFO PAGES 262 TO 266

Can be used as bookmark



COLLECTION BOX

Collection Box (1, 2 & 3 units)

**EXTERNAL PACKAGING**



250 ± 2,8KG

BIC GRAPHIC

BIC® WRITING INSTRUMENTS

OTHER WRITING INSTRUMENTS

NOTEBOOKS

BIC® / D'JEEP® LIGHTERS AND BIC® CASES

BIC® PACKAGING

GENERAL INFORMATION

See pages 274-277 for a detailed explanation of the icons

# BIC® VELLEDA® WHITE BOARD MARKER FINE

Velleda®

Decoration

1651

**BIC® VELLEDA® WHITE BOARD MARKER FINE**  
1651



01/04

●  
Colour ink



01/02

●  
Colour ink

100%

1651

**BIC® VELLEDA® WHITE BOARD MARKER FINE**  
1651

A SP: max. 1 col.

MOQ 500 units

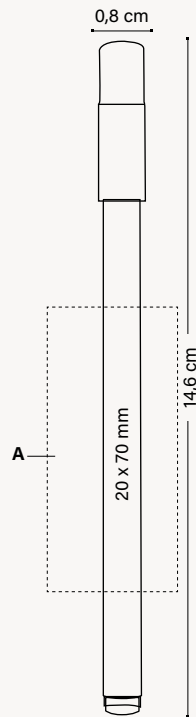

## OPTIONAL SPECIAL PACKAGING



MARKING SET

*Now you can have it as a set!*

+ INFO PAGES 262 TO 266

## EXTERNAL PACKAGING



500 ± 3,2KG



MANUFACTURED AND PRINTED IN BIC FACTORIES

FABRIQUÉ EN FRANCE



MADE IN FRANCE



REGULATORY COMPLIANCE



RESISTANT TIP



## WRITING MODES



MARKER MK

## PRINTING TECHNIQUES



SCREEN PRINTING

## SUSTAINABILITY



IMPRIM'VERT®

# BIC® VELLEDA® WHITE BOARD MARKER GRIP



Decoration

1213

## BIC® VELLEDA® WHITE BOARD MARKER GRIP

1213

A/B SP: max. 3 col.

MOQ 250 units

1213

## BIC® VELLEDA® WHITE BOARD MARKER GRIP

1213



Textured rubberised grip for more precision and control

100%

01/02

Colour ink

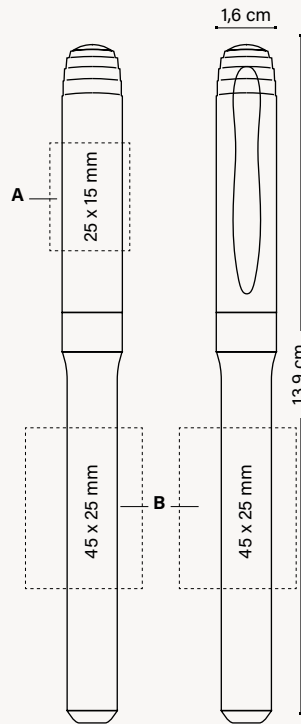

### OPTIONAL SPECIAL PACKAGING



MARKING SET

+ INFO PAGES 262 TO 266

Can be used as bookmark

### EXTERNAL PACKAGING



250 ± 2,7KG



MANUFACTURED AND PRINTED IN BIC FACTORIES



REGULATORY COMPLIANCE

#### WRITING MODES



MARKER MK

#### PRINTING TECHNIQUES



SCREEN PRINTING

#### SUSTAINABILITY



# BIC® MARK-IT PERMANENT MARKER

Decoration

1214

**BIC® MARK-IT  
PERMANENT  
MARKER**  
1214



01/02  
●  
Colour ink

01/04  
●  
Colour ink

100%

←  
*Textured rubberised  
grip for more  
precision and control*

1214

**BIC® MARK-IT  
PERMANENT MARKER**  
1214

A/B SP: max. 3 col.

MOQ 250 units

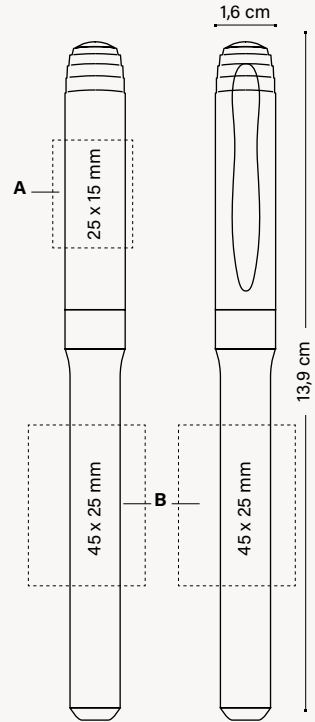

OPTIONAL SPECIAL PACKAGING

EXTERNAL PACKAGING



MARKING  
SET



250 ± 2,8KG

*You can have  
it as a set!*

+ INFO PAGES 262 TO 266

*Can be used  
as bookmark*



MANUFACTURED  
AND PRINTED IN  
BIC FACTORIES



REGULATORY  
COMPLIANCE

RESISTANT  
TIP

WRITING MODES



MARKER  
MK

PRINTING TECHNIQUES



SCREEN  
PRINTING

SUSTAINABILITY



# BIC® PERMANENT MARKER ECOLUTIONS®

ecolutions



MADE FROM  
**52% RECYCLED MATERIAL\***

Add the Möbius loop to your artwork at no additional charge. Please specify "Print the Möbius loop" on your order. (Möbius loop imprint defaults to left-hand hand corner.)

\*Excluding ink system



PHARMACEUTICAL WASTE

Decoration

1210

**BIC® PERMANENT MARKER**  
ecolutions® 1210

A SP: max. 1 col.

MOQ 250 units

1210

**BIC® PERMANENT MARKER**  
ecolutions® 1210



02

Colour ink

02

Colour ink

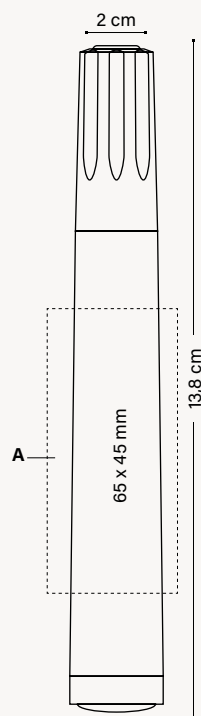

EXTERNAL PACKAGING



MANUFACTURED AND PRINTED IN BIC FACTORIES



FABRIQUÉ EN FRANCE MADE IN FRANCE



REGULATORY COMPLIANCE



RESISTANT TIP



WRITING MODES



MARKER MK

PRINTING TECHNIQUES



SCREEN PRINTING

SUSTAINABILITY



PHARMACEUTICAL WASTE

IMPRIM'VERT®

ecolutions®

\*The percentage is calculated on total weight of product excluding ink system. Due to the recycled content of the raw materials used to make the product, we cannot guarantee that the colours shown in the catalogue or colours customised to order will always have the same colour and appearance. See pages 274-277 for a detailed explanation of the icons.

# BIC® MECHANICAL PENCILS

**Stay sharp with these first-class mechanical pencils! They're solid and resistant, never need sharpening and write smoother and darker than ever!**

FR

Toujours prêts avec ces porte-mines de grande qualité. Ils sont solides et leurs mines sont résistantes. Ils n'ont pas besoin d'être taillés et offrent une écriture plus fluide et plus intense que jamais !

IT

Sempre pronti con questi portamine di qualità superiore. Sono solidi e resistenti, non hanno bisogno di essere temperati e scrivono in modo più morbido e intenso che mai!

DE

Stets schreibbereit mit diesen Qualitäts-Druckbleistiften. Solide und resistent, ohne Anspitzen, schreiben diese Bleistifte leichter und kräftiger denn je!

ES

Siempre preparados con estos portaminas de calidad superior. Son sólidos, resistentes y no es necesario sacarle punta. ¡Escribe más fluido e intenso que nunca!



**BIC® MATIC®**  
**BIC® MEDIA CLIC MECHANICAL PENCIL**  
**BIC® MEDIA CLIC GRIP MECHANICAL PENCIL**

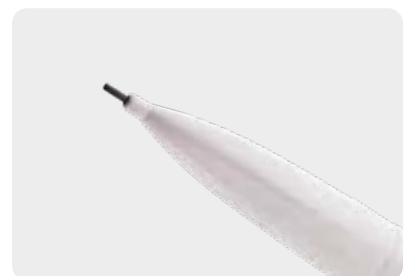

*ECO version and standard at the same price!*

**ecolutions®**



MADE FROM **74% RECYCLED MATERIAL\***

Add the Möbius loop to your artwork at no additional charge. Please specify it on your order. (Möbius loop imprint defaults to left-hand corner.)

\*Excluding lead



PHARMACEUTICAL WASTE

1120

**BIC® MATIC®**  
1120 Opaque



02/02

12/12

03/03

07/07

01/01

100%

1E40

**BIC® MATIC®**  
**ecolutions®** 1E40 Opaque



04/8C

100%

*\*The percentage is calculated based on the total weight of the mechanical pencil excluding lead. Due to the recycled content of the raw materials used to make the product, we cannot guarantee that the colours shown in the catalogue or colours customised to order will always have the same colour and appearance.*

1120 / 1E40

**BIC® MATIC**

1120

**ecolutions® 1E40**

A SP: max. 1 col.

B/C: max. 2 col.

MOQ 500 units

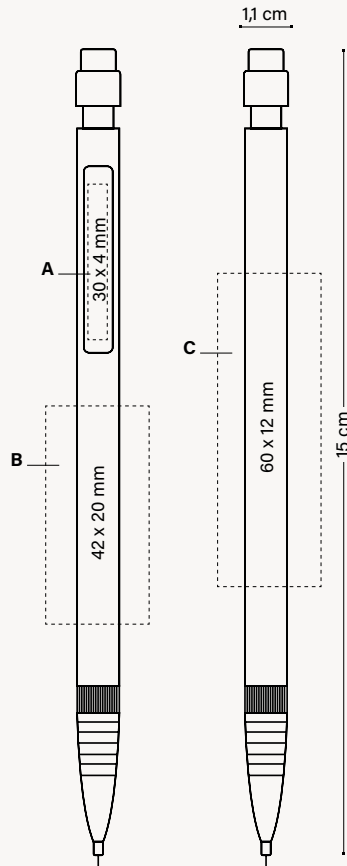

**OPTIONAL SPECIAL PACKAGING**



PLASTIC  
POUCH

+ INFO PAGES 262 TO 266

*Can be used  
as bookmark*

**EXTERNAL PACKAGING**



500 ± 3,1 KG

**Decoration**



MANUFACTURED  
AND PRINTED IN  
BIC FACTORIES



FABRIQU   
EN FRANCE

MADE IN FRANCE



REGULATORY  
COMPLIANCE



ISO  
certified



SMOOTHER AND  
DARKER WRITING



EASY TO  
USE AND ERASE



2 LEADS 9 CM

**WRITING  
MODES**



MECHANICAL PENCIL MP  
Ø 0,7 MM

**PRINTING  
TECHNIQUES**



SCREEN PRINTING

**SUSTAINABILITY**



IMPRIM'VERT®

**ecolutions®**



PHARMACEUTICAL  
WASTE

BIC  
GRAPHIC

BIC®  
WRITING INSTRUMENTS

OTHER WRITING  
INSTRUMENTS

NOTEBOOKS

BIC® / DJEOP® LIGHTERS  
AND BIC® CASES

BIC®  
PACKAGING

GENERAL  
INFORMATION

See pages 274-277 for a detailed explanation of the icons.

# BIC® MEDIA CLIC MECHANICAL PENCIL

---

1028



*Iconic BIC® Boy  
is embossed*

**BIC® MEDIA CLIC**  
1028 Mechanical pencil  
Opaque



13



5C

1028

**BIC® MEDIA CLIC**  
1028 Mechanical pencil  
Frosted



39

# BIC® MEDIA CLIC GRIP MECHANICAL PENCIL

ECO version and standard at the same price!

**ecolutions®**



MADE FROM **98% RECYCLED MATERIAL\***  
\*From barrel



PLASTIC CAR PARTS

## 1021

**BIC® MEDIA CLIC GRIP**  
1021 Mechanical pencil  
Frosted



71/69

82/69

40/69

100%

## 1E21

**BIC® MEDIA CLIC GRIP**  
**ecolutions®** 1E21 Mechanical pencil  
Opaque



01/03

01/05

01/02

01/07

100%

\* The percentage is calculated based on total weight of the barrel. Due to the recycled content of the raw materials used to make the product, we cannot guarantee that the colours shown in the catalogue or colours customised to order will always have the same colour and appearance.

# BIC® MEDIA CLIC MECHANICAL PENCIL

1028

**BIC® MEDIA CLIC**  
1028 Mechanical pencil

1021 / 1E21

**BIC® MEDIA CLIC GRIP**  
1021 Mechanical pencil  
eColutions® 1E21 Mechanical pencil

**MIX & MATCH** No extra charge

MOQ 500 units  
Standard colours combination

## Clip

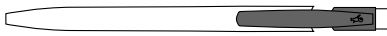

Opaque

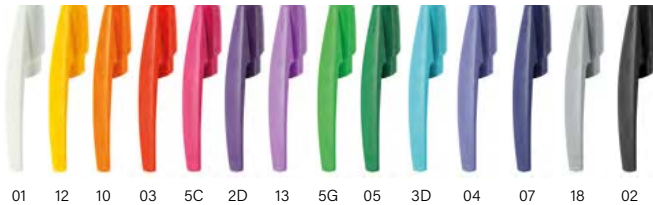

Frosted



01 12 10 03 5C 2D 13 5G 05 3D 04 07 18 02 69

## Barrel



Opaque



5C 13

Frosted



39

## Barrel & Grip

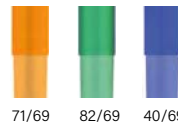

71/69 82/69 40/69

**britePix DIGITAL** THE SOLUTION FOR FULL COLOUR COMMUNICATION!

**eColutions®**



PLASTIC CAR PARTS

Standard colours combination\*

**Barrel & Grip**

Opaque



01/03 01/05 01/07 01/02



\*From barrel  
Add the Möbius loop to your artwork at no additional charge. Please specify "Print the Möbius loop" on your order. (Möbius loop imprint defaults to left-hand corner.)

All colour range available in Digital britePix™

Exact colour match: ≥ 10.000 units 1028  
Exact colour match: ≥ 20.000 units 1021 / 1E21



**MIX & MATCH**

MANUFACTURED AND PRINTED IN BIC FACTORIES



PERSONALIZED COLOURS

WRITING MODES



MECHANICAL PENCIL MP

PRINTING TECHNIQUES



SP SCREEN PRINTING



DG DIGITAL

SUSTAINABILITY

**eColutions®**



PLASTIC CAR PARTS

Decoration

1028

**BIC® MEDIA CLIC**

1028 Mechanical pencil

A SP: max. 4 col.

B SP: max. 2 col.

C DG: full-colour

MOQ 500 units.

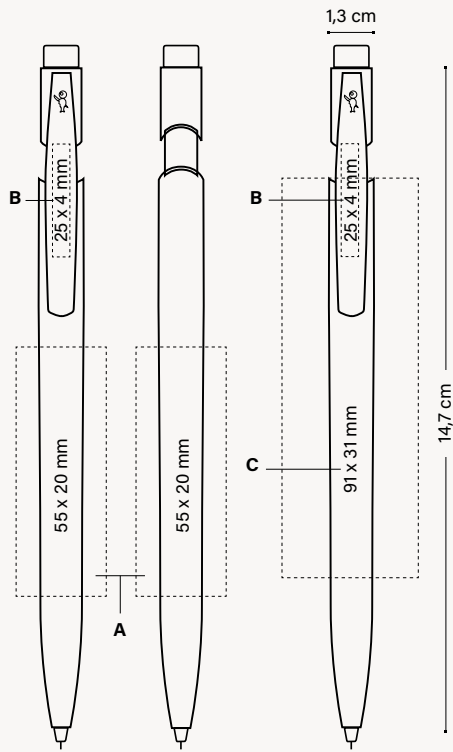

OPTIONAL SPECIAL PACKAGING



ECO SLEEVE

PLASTIC POUCH

WINDOW BOX

+ INFO PAGES 262 TO 266

Can be used as bookmark

EXTERNAL PACKAGING



500 ± 4,1 KG

Decoration

1021 / 1E21

**BIC® MEDIA CLIC GRIP**

1021 Mechanical pencil

1E21 Mechanical pencil

D SP: max. 4 col.

E SP: max. 2 col.

F DG: full-colour

MOQ 500 units.

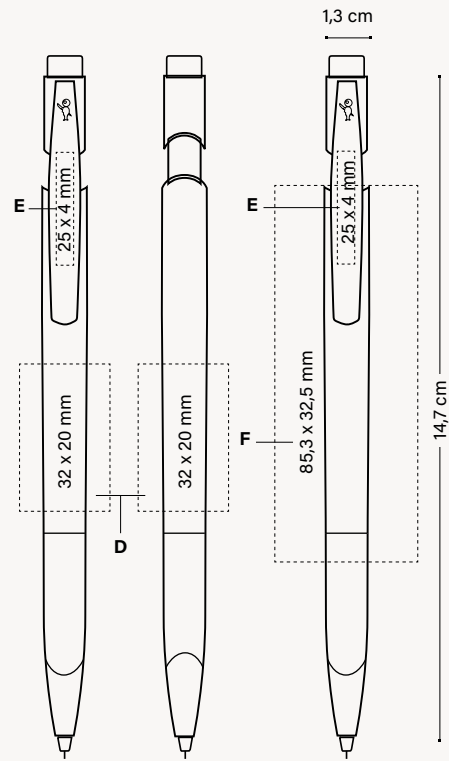

OPTIONAL SPECIAL PACKAGING



ECO SLEEVE

PLASTIC POUCH

WINDOW BOX

+ INFO PAGES 262 TO 266

Can be used as bookmark

EXTERNAL PACKAGING



500 ± 4,3 KG



MANUFACTURED AND PRINTED IN BIC FACTORIES



MADE IN SPAIN

WRITING MODES



MECHANICAL PENCIL MP

PRINTING TECHNIQUES



SCREEN PRINTING



DIGITAL

SUSTAINABILITY



PLASTIC CAR PARTS

See pages 274-277 for a detailed explanation of the icons.

# BIC® PENCILS

# BIC® KIDS EVOLUTION®

# COLOURING SET

---

Graphite and colouring pencils made from synthetic resin and wood-free, that will not splinter in the event of breaking.

FR

**Crayons BIC® et BIC® Kids Evolution® Colouring set**

Crayons de graphite et de couleur fabriqués en résine synthétique et sans bois, qui ne font pas d'écharde en cas de brisure.

IT

**Matite BIC® e BIC® Kids Evolution® Colouring set**

Matite di grafite e colorate realizzate in resina sintetica e senza legno, che non scheggiano in caso di rottura.

DE

**BIC® Bleistifte und BIC® Kids Evolution® Colouring Set**

Graphit- und Farbstifte aus synthetischem Harz und ohne Holz, die bei Bruch nicht splintern.

ES

**Lápices BIC® y BIC® Kids Evolution® Colouring set**

Lápices de grafito y de colores fabricados con resina sintética y sin madera, que no se astillan en caso de romperse.



**BIC® PENCILS**  
**BIC® KIDS EVOLUTION®**  
**COLOURING SET**



# BIC® EVOLUTION® ECOLUTIONS®

**EVOLUTION®** **ecolutions®**

**britePix DIGITAL** THE SOLUTION FOR FULL COLOUR COMMUNICATION!

**britePix DIGITAL** THE SOLUTION FOR FULL COLOUR COMMUNICATION!

**Embossed iconic BIC® brand!**



MADE FROM **64% RECYCLED MATERIAL\***



FRIGIDES AND YOGURT POTS



MADE FROM **52% RECYCLED MATERIAL\***



FRIGIDES AND YOGURT POTS

1150

**GRAPHITE PENCIL CUT END**  
ecolutions® 1150

1151

**GRAPHITE PENCIL WITH ERASER**  
ecolutions® 1151



Protective sheath

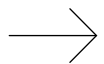

20



02



03



01

100%



01

100%

360° Printing



20



02



03



01

100%



01

100%

360° Printing

\*The percentage is calculated based on total weight of the product. Due to the recycled content of the raw materials used to make the product, we cannot guarantee that the colours shown in the catalogue or colours customised to order will always have the same colour and appearance.



MADE FROM UP TO  
**64% RECYCLED MATERIAL\***



Add the Möbius loop to your artwork at no additional charge. Please specify it on your order. (Möbius loop imprint defaults to left-hand hand corner.)\*\*

1150 / 1151

**GRAPHITE PENCIL**

1150 / 1151

**MIX & MATCH**

No extra charge

MOQ 500 units  
Standard colours combination

**Eraser**

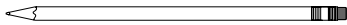

Opaque



**Ferrule**

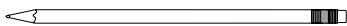

Opaque



**Barrel**



Opaque

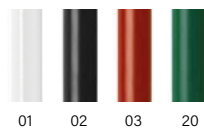

**MIX & MATCH**



MANUFACTURED AND PRINTED IN BIC FACTORIES

FABRIQUÉ EN FRANCE

MADE IN FRANCE



REGULATORY COMPLIANCE



RESISTANT TIP



NO SPLINTER



PROTECTIVE SHEATH



EASY TO USE AND ERASE



WRITING MODES



PENCIL PC HB Ø 2,3MM



PRINTING TECHNIQUES



SCREEN PRINTING



DIGITAL

SUSTAINABILITY



IMPRIM'VERT®

ecolutions®

BIC GRAPHIC

BIC WRITING INSTRUMENTS

OTHER WRITING INSTRUMENTS

NOTEBOOKS

BIC / D'JEEP® LIGHTERS AND BIC® CASES

BIC® PACKAGING

GENERAL INFORMATION

\*\*Percentage indicated in the Möbius loop depend on the product selected (1150 or 1151). Please, see details at the product description.

See pages 274-277 for a detailed explanation of the icons.

1150

**BIC® EVOLUTION® ECOLUTIONS®**  
**ecolutions® 1150** (Pencil cut end)

A SP: max. 1 col.

MOQ 500 units

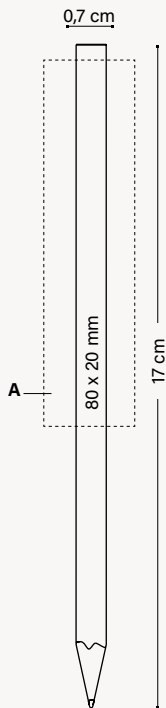

1151

**BIC® EVOLUTION® ECOLUTIONS®**  
**ecolutions® 1151** (Pencil with eraser)

MOQ 500 units

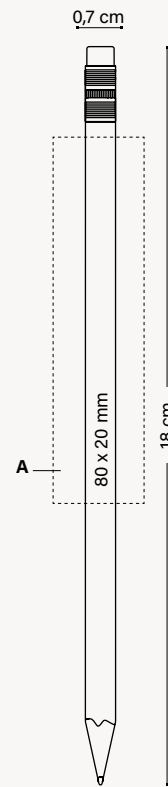

**OPTIONAL SPECIAL PACKAGING**

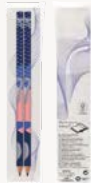

PLASTIC  
 POUCH  
 (x 3 UNITS)

+ INFO PAGES 262 TO 266

*Can be used  
 as bookmark*

**EXTERNAL PACKAGING**



500 ± 3,5 KG

Decoration

1150

**BIC® EVOLUTION® ECOLUTIONS®**  
**ecolutions® 1150** (Pencil cut end Digital)

A DG: full-colour (area for images)

MOQ 500 units

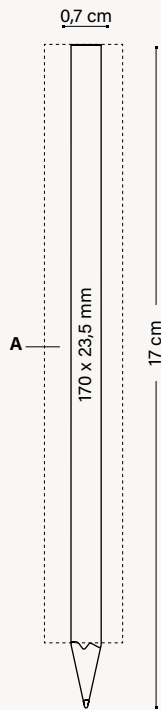

1151

**BIC® EVOLUTION® ECOLUTIONS®**  
**ecolutions® 1151** (Pencil with eraser Digital)

MOQ 500 units

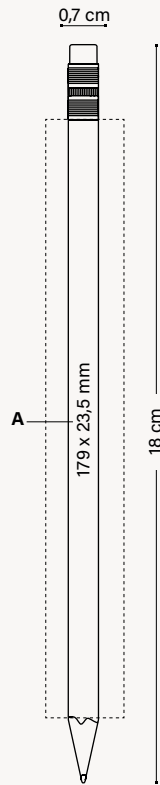

OPTIONAL SPECIAL PACKAGING



PLASTIC POUCH (X 3 UNITS)

+ INFO PAGES 262 TO 266

*Can be used as bookmark*

EXTERNAL PACKAGING



500 ± 3,5 KG



MANUFACTURED AND PRINTED IN BIC FACTORIES



MADE IN FRANCE



REGULATORY COMPLIANCE



RESISTANT TIP



NO SPLINTER



PROTECTIVE SHEATH



EASY TO USE AND ERASE

WRITING MODES



PENCIL PC HB Ø 2,3MM

PRINTING TECHNIQUES



SCREEN PRINTING



DIGITAL

SUSTAINABILITY



IMPRIM'VERT®

ecolutions®



FRIDGES AND YOGURT POTS

See pages 274-277 for a detailed explanation of the icons.

# BIC® KIDS EVOLUTION® COLOURING SET



Ultra-resistant Wood-free pencils that are easy to sharpen.  
Ideal for everyday drawing and colouring.



MADE FROM  
51% RECYCLED MATERIAL\*

\*Excluding lead



FRIDGES AND  
YOGURT POTS



*Safe usage  
for kids*

- Does not splinter on breaking
- Resistant to chewing

1608

**BIC® KIDS EVOLUTION® COLOURING SET**  
eColutions® 1608

*Fully customisable  
carton wallet\*\**

**NEW!**



\*The percentage is calculated based on the total weight of the pencil excluding lead.  
\*\*Non-personalisable pencils

1608

**BIC® KIDS EVOLUTION® COLOURING SET**  
ecolutions® 1608

A DG: full-colour

MOQ 1200 units.

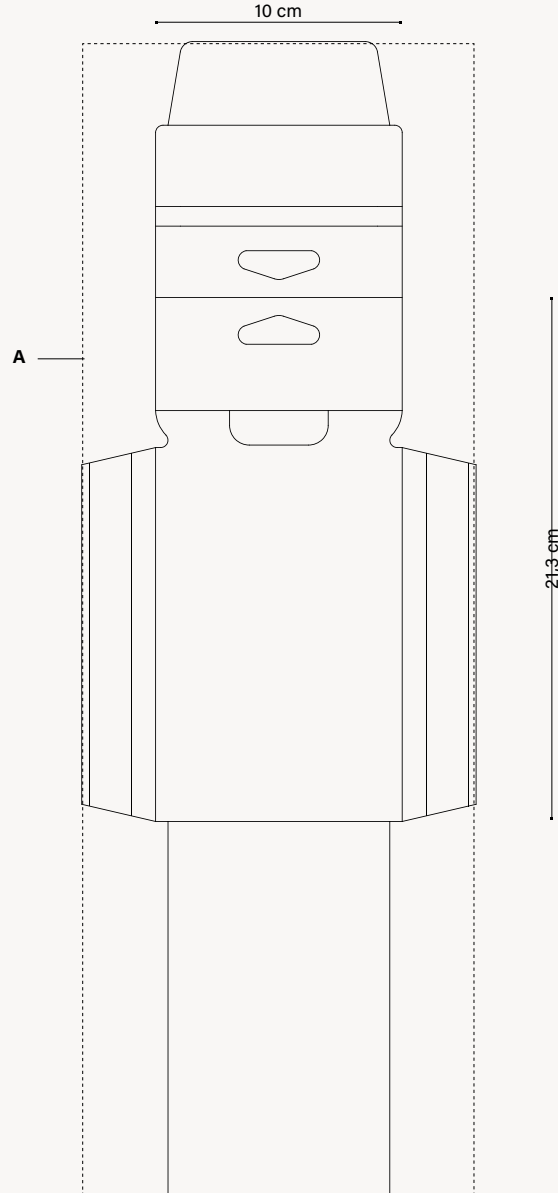

Decoration



WRITING MODES

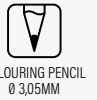

SUSTAINABILITY



EXTERNAL PACKAGING



500 ± 2,5 KG (ONLY PENCIL)  
± 5 KG (WITH CARDBOARD PACKAGING)

PACKAGING



See pages 274-277 for a detailed explanation of the icons.

BIC GRAPHIC

BIC® WRITING INSTRUMENTS

OTHER WRITING INSTRUMENTS

NOTEBOOKS

BIC® / DLEEP® LIGHTERS AND BIC® CASES

BIC® PACKAGING

GENERAL INFORMATION

# SPROUT™ GRAPHITE PENCIL



This pencil enables you to convey a meaningful message and sets the foundation for a lasting relationship. The sustainable pencil that you can plant after use and grow into herbs, vegetables, fruits or flowers.

**FR**  
Le crayon durable que vous pouvez planter après son utilisation et faire pousser des plantes, des légumes, des fruits ou des fleurs.

**DE**  
Dieser Stift ermöglicht es Ihnen, tiefgreifende Botschaften zu übermitteln und legt den Grundstein für dauerhafte Beziehungen. Der nachhaltige Bleistift kann nach Gebrauch eingepflanzt werden, um sich in Kräuter, Obst, Gemüse oder Blumen zu verwandeln.

**IT**  
La matita sostenibile che può essere piantata dopo essere stata utilizzata e cresce come un'erba, un vegetale, un frutto o un fiore.

**ES**  
El lápiz sostenible que puedes plantar después de ser utilizado y crece como una hierba, un vegetal, una fruta o una flor.

53062

SPROUT™ GRAPHITE PENCIL  
53062

With seeds  
→



Standard barrel

Customised barrel

Standard cardboard!



Standard cardboard packaging

Customisable cardboard!



Personalised cardboard packaging



Rear side



Graphite Lead

Once the pencil is too short to write with, plant the stub and watch your message turn into a pot of beautiful herbs, flowers, fruits or vegetables.

Choose between 9 different seeds!

**NEW!**



STRAWBERRY



Spruce



Sunflower



Daisy



Sage



Cherry tomato



Forget-me-not



Basil



Thyme

Decoration

53062

**SPROUT™ GRAPHITE PENCIL**

53062

A LE  
B DG

MOQ 100 units

*Pencil sharpening is offered at an extra charge*

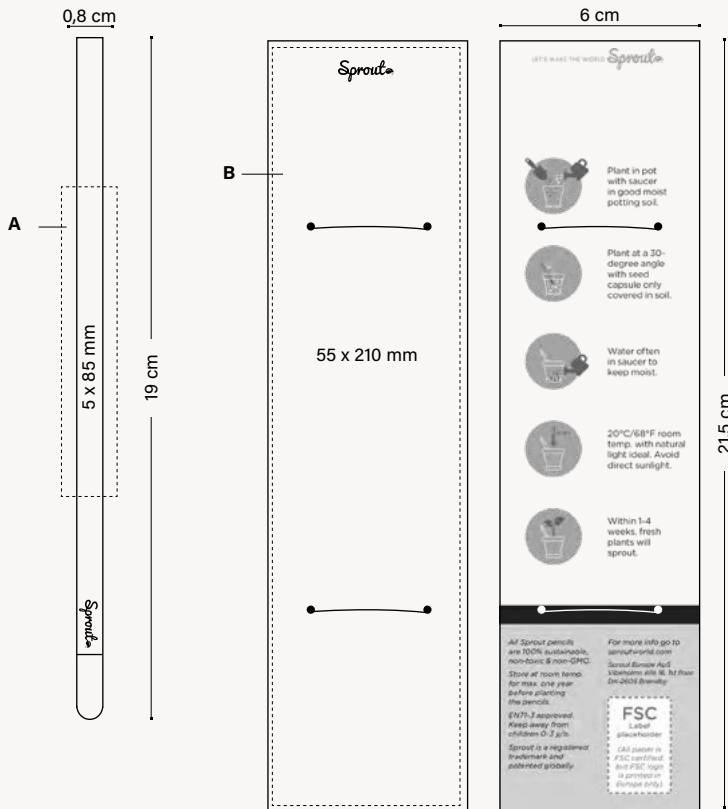

**EXTERNAL PACKAGING**



500 ± 2,5 KG (ONLY PENCIL)  
± 5 KG (WITH CARDBOARD PACKAGING)

**PACKAGING**



**WRITING MODES**



PENCIL PC HB  
Ø 2,3MM

**PRINTING TECHNIQUES**



LASER



DIGITAL

**SUSTAINABILITY**



FSC AND  
RECYCLABLE CARDBOARD



CHECK OUT THE VIDEO

See pages 274-277 for a detailed explanation of the icons.

BIC GRAPHIC

BIC WRITING INSTRUMENTS

OTHER WRITING INSTRUMENTS

NOTEBOOKS

BIC / DEEP LIGHTERS AND BIC CASES

BIC PACKAGING

GENERAL INFORMATION

# Contents

## BIC® / DJEEP® LIGHTERS AND BIC® CASES

---

# 04

<b>BIC® LIGHTERS</b>		<b>OTHER PRODUCTS</b>	
BIC® J25 Lighter	222	BIC® EZ Reach™	244
BIC® J23 Lighter	226	BIC® Pocket Ashtray	248
BIC® J26 Lighter	230		
BIC® J38 Lighter	234	<b>DJEEP® LIGHTERS</b>	
		DJEEP® D1 Lighter	250
<b>BIC® LIGHTER CASES</b>			
BIC® Styl'it Luxury Case	238		
BIC® Aluminium Flat Case	240		
BIC® Clip Case	241		
BIC® 3D Case	242		

# BIC® lighters.

## Our quality, your safety.

All BIC® lighters meet or exceed international standards and regulations requirements (ISO 9994, EN 13869, ASTM F400, US CPSC).  
Don't risk it, buy a BIC® lighter!



**BIC® is number one worldwide for branded lighters.\***



**100% of lighters are manufactured by BIC in Europe. All BIC® Lighters are made in BIC factories. This is the starting block of the BIC® lighter safety guarantee.**

## 50 YEARS

**BIC has acquired 50 years of incredible manufacturing expertise to guarantee the safety and quality of its products.**

## 50 CHECKS

**Before leaving the factory, every BIC® Lighter undergoes more than 50 automatic quality and security checks.**

FR  
BIC® est le numéro un mondial des briquets de marque.

100% des briquets sont fabriqués par BIC en Europe.

BIC a acquis 50 ans d'une incroyable expertise de fabrication afin de garantir la sécurité et la qualité de ses produits.

Avant de quitter l'usine, chaque briquet BIC® subit plus de 50 contrôles automatiques de qualité et de sécurité.

DE  
BIC® ist weltweit die Nummer eins bei Markenfeuerzeugen.

Alle Feuerzeuge von BIC werden zu 100% in BIC-Fabriken in Europa hergestellt.

BIC hat in 50 Jahren eine unglaubliche Fertigungskompetenz erworben und kann somit die Sicherheit und Qualität seiner Produkte gewährleisten.

Jedes BIC® Feuerzeug durchläuft vor Verlassen des Werks über 50 automatische Qualitäts- und Sicherheitskontrollen.

IT  
BIC® è il numero uno al mondo fra gli accendini di marca.

Il 100% degli accendini è prodotta BIC in Europa.

BIC ha acquisito 50 anni di incredibile esperienza di produzione per garantire la sicurezza e la qualità dei propri prodotti.

Prima di lasciare la fabbrica, ogni accendino BIC® viene sottoposto a oltre 50 controlli automatici di qualità e sicurezza.

ES  
BIC® es el número uno mundial en encendedores de marca.

El 100 % de los encendedores de BIC se fabrica en Europa.

Durante 50 años BIC ha adquirido increíbles conocimientos de fabricación para garantizar la seguridad y calidad de sus productos.

Antes de salir de fábrica, cada encendedor BIC® se somete a más de 50 controles automáticos de calidad y seguridad.

## CHOOSE WISELY! BIC® Lighters



**BIC® J25  
Lighter**

 UP TO  
1450



**BIC® J23  
Lighter**

 UP TO  
1800



**BIC® J26  
Lighter**

 UP TO  
3000



**BIC® J38  
Lighter**

 UP TO  
1800

# BIC® LIGHTERS

The iconic, well-loved and time-honoured shapes of BIC® lighters remain on trend!

Four different sizes and a wide range of colour combinations.

FR

Le célèbre briquet BIC®, une icône indémodable, avec un design toujours tendance !

5 tailles différentes et une vaste gamme de combinaisons de couleurs.

IT

L'iconico, amato e intramontabile design dell'accendino BIC® resta di tendenza!

5 diverse misure e una vasta gamma di combinazioni di colori.

DE

Das legendäre, beliebte und bewährte Design des BIC®-Feuerzeugs liegt weiter im Trend!

5 verschiedene Größen und eine breite Farbkombinationspalette.

ES

¡El diseño icónico, querido y atemporal del encendedor BIC® sigue siendo tendencia!

5 tamaños distintos y una amplia gama de combinaciones de colores.



- BIC® J25 LIGHTER**
- BIC® J23 LIGHTER**
- BIC® J26 LIGHTER**
- BIC® J38 LIGHTER**
- BIC® STYL'IT LUXURY CASE**
- BIC® ALUMINIUM FLAT CASE**
- BIC® CLIP CASE**
- BIC® 3D CASE**
- BIC® POCKET ASHTRAY**



# BIC® J25 LIGHTER

## Perfect for your pocket!

2360 / 2364



Iconic BIC® Boy and BIC® logo engraved!

### BIC® J25 LIGHTER

2360

2364 All Black



01

57

57

8G

03

11

59

24

04



25

25

6W

90

02

02

02

02

100%

FR

Parfait pour  
votre poche !

DE

Passt perfekt in  
die Hosentasche!

IT

Perfetto per  
le tue tasche!

ES

¡Perfecto para  
tu bolsillo!

Decoration

2360/2364

**BIC® J25 LIGHTER**  
2360/2364  
A/C SP: max. 4 col.  
MOQ 300 units

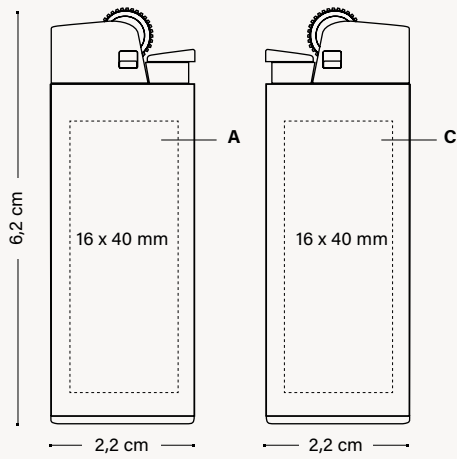

2360/2364

**BIC® J25 LIGHTER BRITEPIX™**  
2360 / 2364  
A/C BP: full-colour

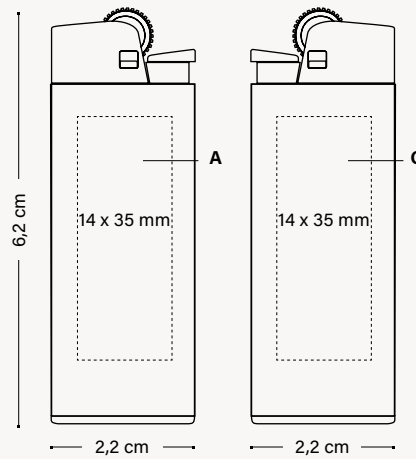

PACKAGING



STANDARD PACKAGING:  
IN TRAY OF 50 UNITS

100% recycled!

EXTERNAL PACKAGING



600 ± 76 KG



FSC AND  
RECYCLABLE  
CARDBOARD



PASTEL  
MADE IN FRANCE



PRINTING  
TECHNIQUES



SUSTAINABILITY



100% ELECTRICITY COMING  
FROM RENEWABLE SOURCES

DIGITAL FINISHES



**BR** BRILLIANT



**MT** MATT

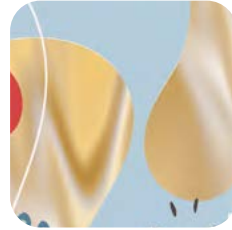

**H** HOLOGRAPHIC SILVER GOLD



**P** PUFFY



**M** METALLIC



**UV** UV



**PG** PUFFY GLITTER

2360

BIC® J25 DIGITAL LIGHTER  
2360



**MT** MATT

**P** PUFFY



**PG** PUFFY GLITTER



**MT** MATT

**M** METALLIC

Decoration

2360

**BIC® J25 DIGITAL LIGHTER**

2360

**A DG:** full-colour

MOQ 600 units

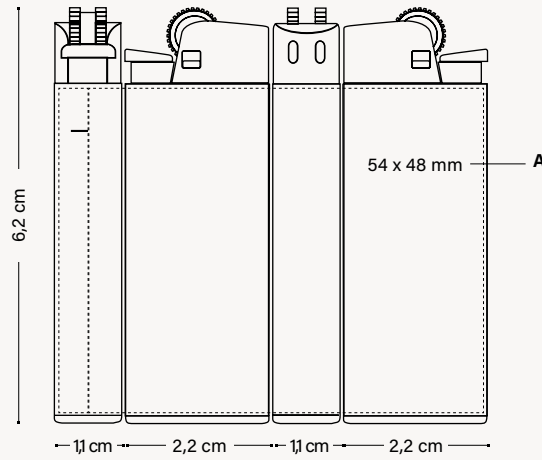

SUSTAINABILITY



100% ELECTRICITY COMING FROM RENEWABLE SOURCES

PACKAGING



100% recycled!

STANDARD PACKAGING:  
IN TRAY OF 50 UNITS

EXTERNAL PACKAGING



600 ± 76 KG



FSC AND RECYCLABLE CARDBOARD

See pages 274-277 for a detailed explanation of the icons

# BIC® J23 LIGHTER



Iconic BIC® Boy  
and BIC® logo  
engraved!

2340

BIC® J23 LIGHTER  
2340



57



12



03



10

*Slim and fits  
everywhere!*



05



04



25



02

2340

**BIC® J23 LIGHTER**

2340

A/C SP: max. 4 col.

MOQ 300 units

**Decoration**

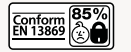
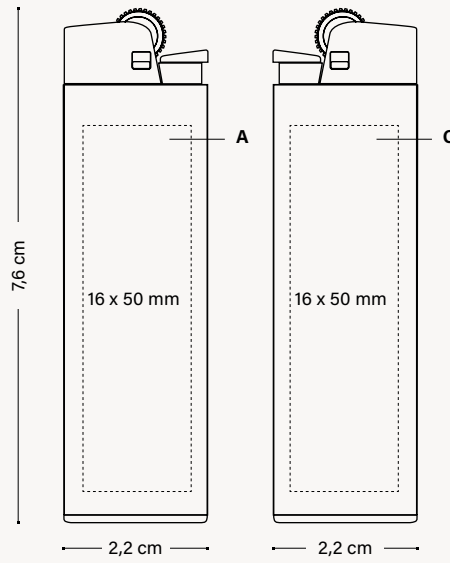

**PRINTING TECHNIQUES**



**SUSTAINABILITY**



**PACKAGING**



100% recycled!

STANDARD PACKAGING:  
IN TRAY OF 50 UNITS

**EXTERNAL PACKAGING**



600 ± 9,5 KG



FSC AND  
RECYCLABLE  
CARDBOARD

See pages 274-277 for a detailed explanation of the icons

DIGITAL FINISHES



**BR** BRILLIANT



**MT** MATT

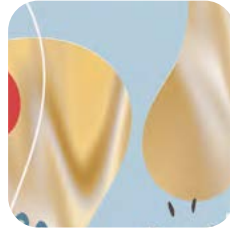

**H** HOLOGRAPHIC SILVER GOLD



**P** PUFFY



**M** METALLIC



**UV** UV



**PG** PUFFY GLITTER

2340

BIC® J23 DIGITAL LIGHTER  
2340



**MT** MATT



**PG** PUFFY GLITTER



**BR** BRILLIANT

**H** HOLOGRAPHIC GOLD

2340

**BIC® J23 DIGITAL LIGHTER**

2340

**A DG:** full-colour

MOQ 600 units

**Decoration**

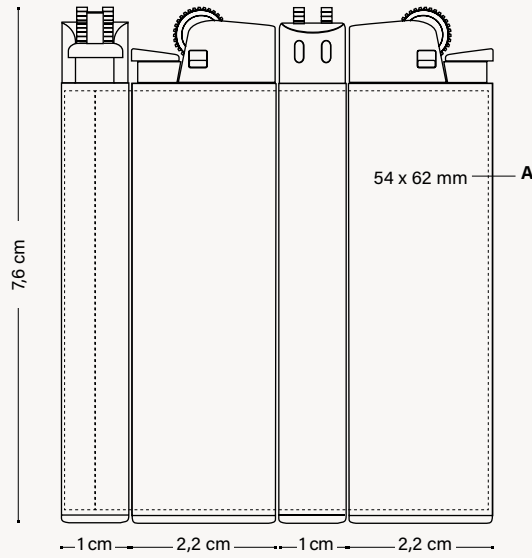

**PRINTING TECHNIQUES**



**PACKAGING**



100% recycled!

STANDARD PACKAGING:  
IN TRAY OF 50 UNITS

**EXTERNAL PACKAGING**



600 ± 9,5 KG



FSC AND  
RECYCLABLE  
CARDBOARD

See pages 274-277 for a detailed explanation of the icons

# BIC® J26 LIGHTER

## The flame that lasts.



Iconic BIC® Boy and BIC® logo engraved!

2320

BIC® J26 LIGHTER

2320



01



57



8G



10



6W

Extra long-lasting: up to 3.000 lights!

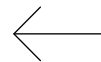

59



24



25



02



03

FR  
**La flamme qui dure.**

DE  
**Die Flamme, die anhält.**

IT  
**La fiamma che dura.**

ES  
**El encendido que dura.**

2320

**BIC® J26 LIGHTER**

2320

A/C SP: max. 4 col.

MOQ 300 units

**Decoration**

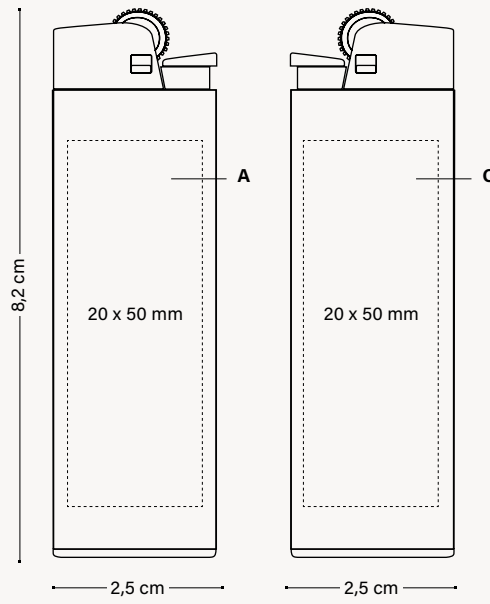

MANUFACTURED AND PRINTED IN BIC FACTORIES



MADE IN SPAIN



REGULATORY COMPLIANCE



UP TO 3.000



**PRINTING TECHNIQUES**



SCREEN PRINTING

**SUSTAINABILITY**



IMPRIM'VERT®



100% ELECTRICITY COMING FROM RENEWABLE SOURCES

**PACKAGING**



100% recycled!

STANDARD PACKAGING:  
IN TRAY OF 50 UNITS

**EXTERNAL PACKAGING**



600 ± 15,1 KG



FSC AND RECYCLABLE CARDBOARD

See pages 274-277 for a detailed explanation of the icons

DIGITAL FINISHES



**BR** BRILLIANT



**MT** MATT

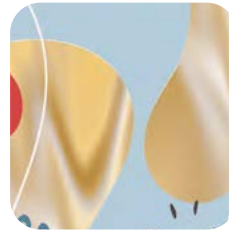

**H** HOLOGRAPHIC SILVER GOLD



**P** PUFFY



**M** METALLIC



**UV** UV



**PG** PUFFY GLITTER

2320

BIC® J26 DIGITAL LIGHTER  
2320



**MT** MATT

**H** HOLOGRAPHIC SILVER



**BR** BRILLIANT



360°  
Printing

**MT** MATT

100%

2320

**BIC® J26 DIGITAL LIGHTER**

2320

**A DG:** full-colour

MOQ 600 units

**Decoration**

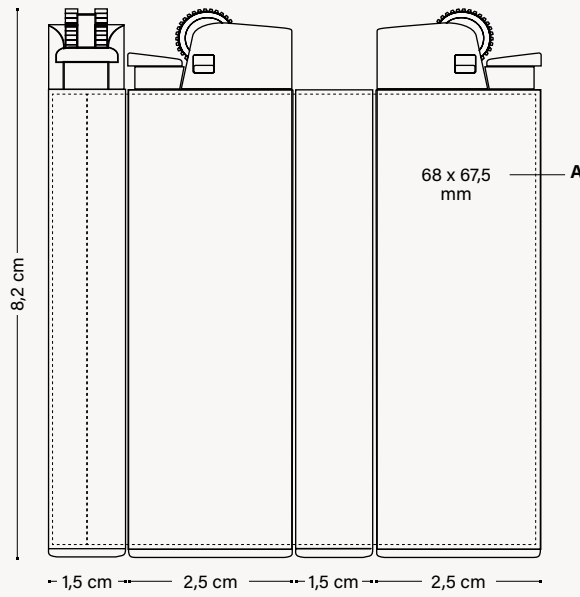

**PRINTING TECHNIQUES**



**SUSTAINABILITY**



100% ELECTRICITY COMING FROM RENEWABLE SOURCES

**PACKAGING**



100% recycled!

STANDARD PACKAGING:  
IN TRAY OF 50 UNITS

**EXTERNAL PACKAGING**



600 ± 15,1 KG



FSC AND  
RECYCLABLE  
CARDBOARD

See pages 274-277 for a detailed explanation of the icons

BIC  
GRAPHIC

BIC®  
WRITING INSTRUMENTS

OTHER WRITING  
INSTRUMENTS

NOTEBOOKS

BIC® / DEEP® LIGHTERS  
AND BIC® CASES

BIC®  
PACKAGING

GENERAL  
INFORMATION

# BIC® J38 LIGHTER

---

2452



Iconic BIC® Boy  
and BIC® logo  
engraved!

**BIC® J38 LIGHTER**  
2452



57



25



02



03

100%

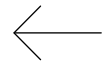

*Elegant and  
comfortable  
lighting!*

2452

**BIC® J38 LIGHTER**

2452

A/C SP: max. 4 col.

MOQ 300 units

**Decoration**

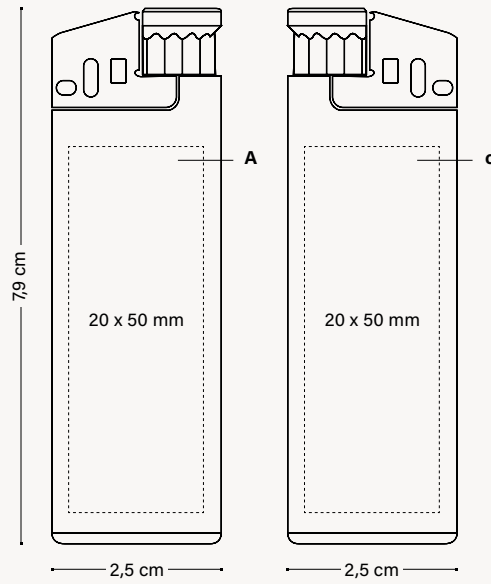

**PRINTING TECHNIQUES**



**SUSTAINABILITY**



**PACKAGING**



100% recycled!

STANDARD PACKAGING:  
IN TRAY OF 50 UNITS

**EXTERNAL PACKAGING**



600 ± 13,2 KG



FSC AND RECYCLABLE CARDBOARD

See pages 274-277 for a detailed explanation of the icons

FINISHES



**BR** BRILLIANT



**MT** MATT

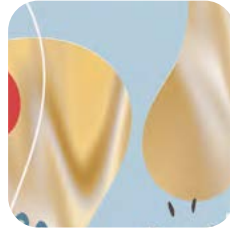

**H** HOLOGRAPHIC SILVER GOLD



**P** PUFFY



**M** METALLIC



**UV** UV



**PG** PUFFY GLITTER

2452

BIC® J38 DIGITAL LIGHTER  
2452



57

**BR** BRILLIANT



57

**MT** MATT



360°  
Printing

100%

57

**MT** MATT

**H** HOLOGRAPHIC GOLD

2452

**BIC® J38 DIGITAL LIGHTER**

2452

**A DG:** full-colour

MOQ 600 units

**Decoration**

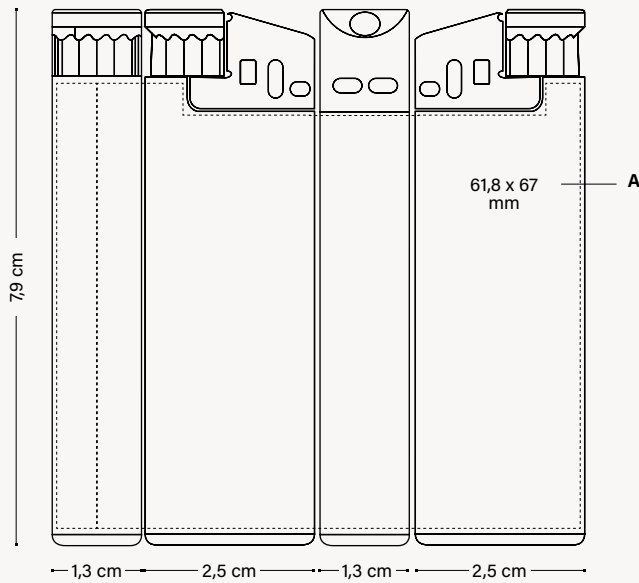

**PACKAGING**



100% recycled!

STANDARD PACKAGING:  
IN TRAY OF 50 UNITS

**EXTERNAL PACKAGING**



600 ± 13,2 KG



FSC AND  
RECYCLABLE  
CARDBOARD

See pages 274-277 for a detailed explanation of the icons

BIC  
GRAPHIC

BIC®  
WRITING INSTRUMENTS

OTHER WRITING  
INSTRUMENTS

NOTEBOOKS

BIC® / DEEP® LIGHTERS  
AND BIC® CASES

BIC®  
PACKAGING

GENERAL  
INFORMATION

# BIC® STYL'IT LUXURY CASE

---

2386

**BIC® STYL'IT LUXURY CASE**  
2386 Neon



*All cases are delivered with a white BIC® 125 lighter!*



59



1G



5C

100%

2386

**BIC® STYL'IT LUXURY CASE**  
2386

**Decoration**

MOQ 100 units  
A/C LE

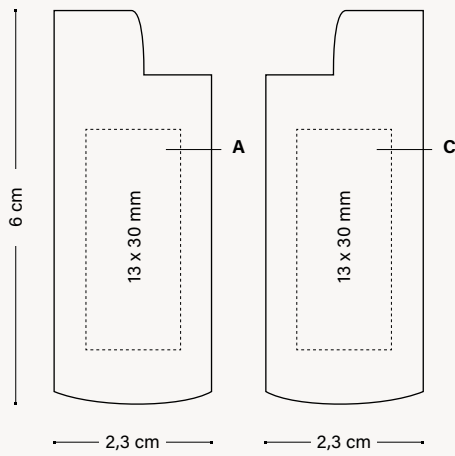

MOQ 100 units  
A/C PD

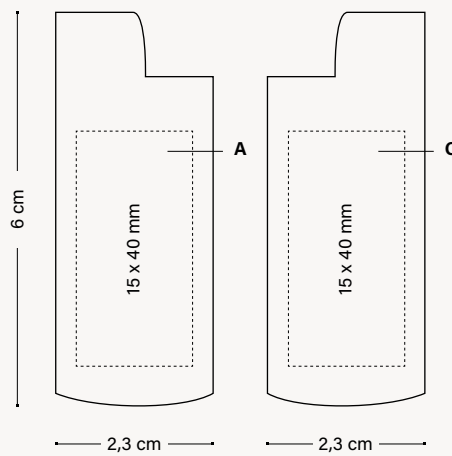

**PACKAGING**



STANDARD PACKAGING:  
BOX FOR 10 UNITS

**EXTERNAL PACKAGING**



300 ± 6,1 KG



FSC AND  
RECYCLABLE  
CARDBOARD



PRINTING  
TECHNIQUES



PAD PRINTING



LASER

SUSTAINABILITY



# BIC® ALUMINIUM FLAT CASE

2156

**BIC® ALUMINIUM FLAT CASE**  
2156

3 customisable sides!



All cases are delivered with a white BIC® J25 lighter!



100%

47

## Decoration

2156

**BIC® ALUMINIUM FLAT CASE**  
2156

MOQ 100 units  
A/C PD: max. 1 col.

MOQ 100 units  
A/B/C BP: full-colour

MOQ 100 units  
A/B/C LE

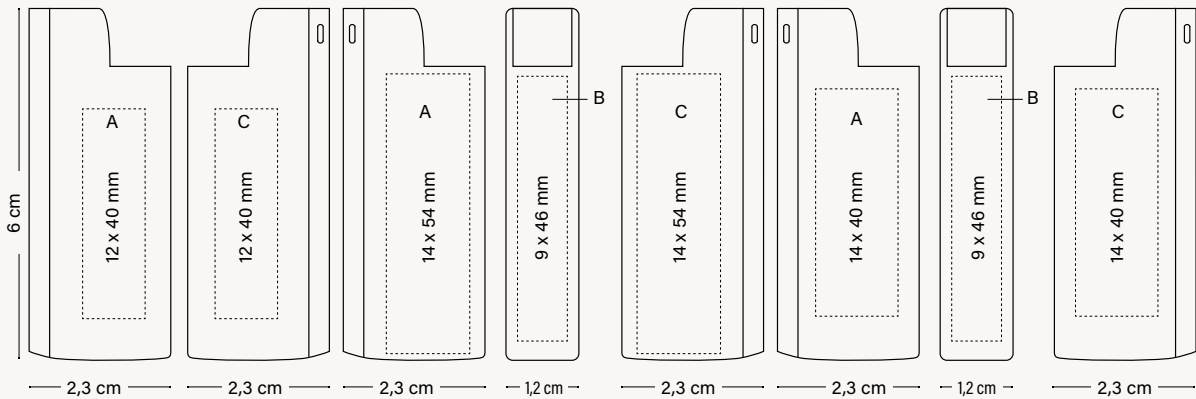

### PACKAGING



STANDARD PACKAGING:  
BOX FOR 50 UNITS

### EXTERNAL PACKAGING



300 ± 75 KG



FSC AND  
RECYCLABLE  
CARDBOARD



PRINTED IN  
BIC FACTORIES

Conform  
ISO 9994



REGULATORY  
COMPLIANCE

Conform  
EN 13869 85%

### PRINTING TECHNIQUES

PD

PAD PRINTING

BP

BRITEPIX™  
BRITEPIX™ PERSONALISATION

LE

LASER

### SUSTAINABILITY



IMPRIM'VERT®

# BIC® CLIP CASE

2398

**BIC® CLIP CASE**  
2398



All cases are delivered with a white BIC® J2S lighter!



03

02

100%

## Decoration

2398

**BIC® CLIP CASE**  
2398

MOQ 100 units  
A/C PD: max. 1 col.

MOQ 100 units  
A/C BP: full-colour  
BP Texture: full-colour

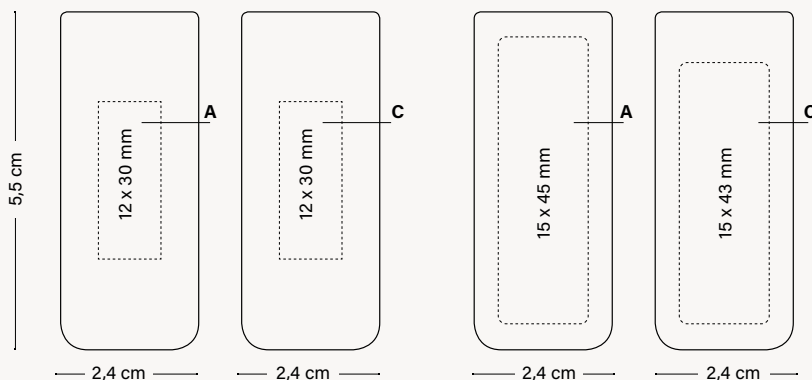

### PACKAGING



STANDARD PACKAGING:  
BOX FOR 50 UNITS

### EXTERNAL PACKAGING



300 ± 75 KG



FSC AND  
RECYCLABLE  
CARDBOARD



PRINTED IN  
BIC FACTORIES



REGULATORY  
COMPLIANCE



### PRINTING TECHNIQUES

PD

PAD PRINTING

BP

BRITPIX™  
BRITPIX™ PERSONALISATION

### SUSTAINABILITY



2395

BIC® 3D CASE  
2395



↑  
*All cases are delivered with a white BIC® J25 lighter!*



↑  
*Convert your logo into a 3D shape!*

2395

**BIC® 3D CASE**

2395

A/C 3D: max. 6 col.

MOQ 1.200 units

**Decoration**



REGULATORY COMPLIANCE



PRINTING TECHNIQUES



EMBOSSING

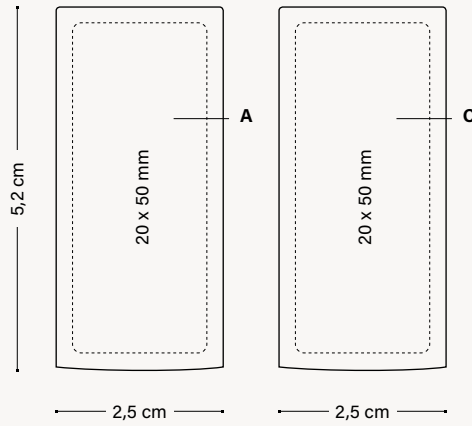

**PACKAGING**



STANDARD PACKAGING:  
BOX FOR 50 UNITS

**EXTERNAL PACKAGING**



300 ± 75 KG



FSC AND  
RECYCLABLE  
CARDBOARD

See pages 274-277 for a detailed explanation of the icons

BIC® EZ REACH™

NEW!

Light up unique moments.

  
**EZ Reach**  
THE ULTIMATE LIGHTER



FR  
Illuminez vos moments uniques.

DE  
Entfachen Sie einzigartige Momente.

IT  
Illumina momenti unici.

ES  
Ilumina momentos únicos.

## The safe flame occasions are endless with the new BIC® EZ Reach™.



FR  
Les occasions de profiter d'une flamme en toute sécurité sont infinies, grâce au nouveau BIC® EZ Reach™.

DE  
Es gibt unzählige Möglichkeiten, mit dem neuen BIC® EZ Reach™ eine sichere Flamme zu entzünden.

IT  
Le occasioni per usare una fiamma sicura sono infinite con il nuovo BIC® EZ Reach™.

ES  
Las ocasiones para una llama segura son infinitas con el nuevo BIC® EZ Reach™.

BIC® EZ REACH™



# SAFETY FLAME

## Helps keep fingers away from the flame



Long lasting with up to 900 flames

### Stable flame

thanks to the pure isobutane gas



### Convenient format

Easily fits in the pocket



Made in Europe



Convenient for different flame occasions



Safe & Reliable



Keeps fingers away from the flame

thanks to its 3.5 cm wand

High force ignition system



Made with 100% electricity coming from renewable sources

### High resistance

Made of high mechanical resistance resin Delrin®

FR

**FLAMME SÛRE.**  
Les doigts restent éloignés de la flamme.

DE

**SICHERHEITS-FLAMME.**  
Hilft die Finger von der Flamme fernzuhalten.

IT

**FIAMMA DI SICUREZZA.**  
Aiuta a tenere le dita lontane dalla fiamma.

ES

**LLAMA SEGURA.**  
Ayuda a mantener los dedos alejados de la llama.

**NEW!**

# The most special moments begin when someone lights the flame.



2450

BIC® EZ REACH™

2450

A SP: max. 1 col.

B BP: full-colour

MOQ 240 units



01

02

03



12

25

04

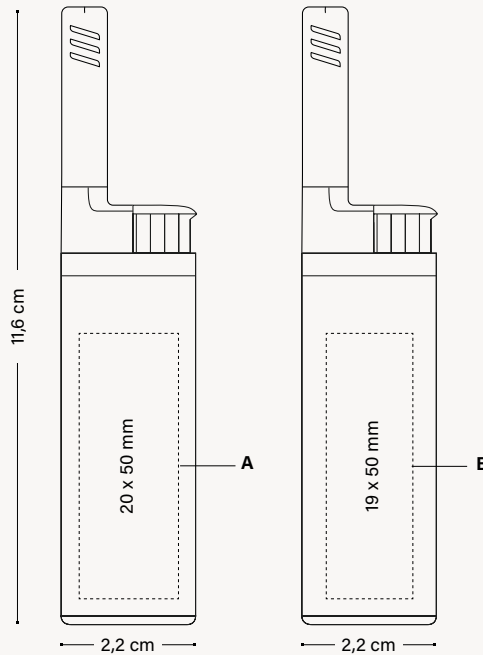

## Decoration



MANUFACTURED AND PRINTED IN BIC FACTORIES



MADE IN EUROPE



REGULATORY COMPLIANCE



UP TO 900



KEEP FINGERS AWAY FROM THE FLAME



EASILY FITS IN THE POCKET

## PRINTING TECHNIQUES



SCREEN PRINTING



BRITEPIX™

## SUSTAINABILITY



100% ELECTRICITY COMING FROM RENEWABLE SOURCES

## PACKAGING



STANDARD PACKAGING:  
IN TRAY OF 20 UNITS

## EXTERNAL PACKAGING



120 ± 3.05 KG



FSC AND RECYCLABLE CARDBOARD

FR

Les moments les plus particuliers commencent lorsque quelqu'un allume la flamme.

DE

Die besonders schönen Momente beginnen, wenn jemand die Flamme entzündet.

IT

I momenti più speciali iniziano quando si accende una fiamma.

ES

Los momentos más especiales comienzan cuando alguien enciende la llama.

[www.bicgraphic.com](http://www.bicgraphic.com)

